



# X3-Hybrid User Manual

5.0kw - 10.0kw



EN



## Solax Power Co., Ltd.

No.288 Shizhu Road, Tonglu Economic Development Zone,  
Tonglu City, Zhejiang Province, China.

**Tel:** +86 0571-56260011

**E-mail:** info@solaxpower.com

614.00206.01

### Copy Declaration

The copyright of this manual belongs to SolaX Power Co.,Ltd.. Any corporation or individual should not plagiarize, partially or fully copy(including software,etc.), and no reproduction or distribution of it in any form or by any means. All rights reserved. SolaX Power Co.,Ltd.,reserves the right of final interpretation.

[www.solaxpower.com](http://www.solaxpower.com)

## Copyright Declaration

The copyright of this manual belongs to SolaX Power Co.,Ltd..Any corporation or individual should not plagiarize,partially copy or fully copy it(including software,etc.), and no reproduction or distribution of it in any form or by any means.All rights reserved. SolaX Power Co.,Ltd.,reserves the right of final interpretation.This information is subject to changes without notice.

## Contents

<b>1 Note on this Manual</b> .....	<b>03</b>
1.1 Scope of Validity .....	03
1.2 Target Group .....	03
1.3 Symbols Used .....	03
<b>2 Safety</b> .....	<b>04</b>
2.1 Important Safety Instructions .....	04
2.2 Explanation of Symbols .....	08
2.3 CE Directives .....	09
<b>3 Introduction</b> .....	<b>10</b>
3.1 Basic Features .....	10
3.2 Work Modes.....	12
3.3 Dimension .....	13
3.4 Terminals of PV Inverter .....	14
<b>4 Technical Data</b> .....	<b>15</b>
4.1 DC input ( apply to version E, C ) .....	15
4.2 AC output/input ( apply to version E, C ) .....	15
4.3 Internal Charger ( apply to version E, C ) .....	16
4.4 Efficiency, Safety and Protection ( apply to version E, C ) .....	16
4.5 EPS output ( apply to version E only ) .....	17
4.6 General Data .....	17
<b>5. Installation</b> .....	<b>18</b>
5.1 Check for Physical Damage .....	18
5.2 Packing List .....	18
5.3 Mounting .....	19
<b>6 Electrical Connection</b> .....	<b>22</b>
6.1 PV Connection .....	22
6.2 Grid Connection .....	24
6.3 EPS Connection( apply to E Version) .....	26
6.4 Battery Connection .....	30

6.5 Earth Connection(mandatory) ..... 33  
 6.6 Meter Connection ..... 34  
 6.7 LAN Connection ..... 36  
 6.8 DRM Connection ..... 37  
 6.9 WiFi Connection(optional) ..... 38  
 6.10 RF Connection(optional) ..... 39  
 6.11 Inverter Manipulation ..... 40

**7. Firmware Upgrading ..... 42**

**8. Setting ..... 44**

8.1 Control Panel ..... 44  
 8.2 Menu Structure ..... 45  
 8.3 LCD Operation ..... 46

**9 Troubleshooting ..... 64**

9.1 Trouble Shooting ..... 64  
 9.2 Routine Maintenance ..... 68

**10 Decommissioning ..... 69**

10.1 Dismantling the Inverter ..... 69  
 10.2 Packaging ..... 69  
 10.3 Storage and Transportation ..... 69

# 1 Notes on this Manual

## 1.1 Scope of Validity

This manual is an integral part of X3-Hybrid, It describes the assembly, installation, commissioning, maintenance and failure of the product. Please read it carefully before operating.

X3-Hybrid-5.0-N-E	X3-Hybrid-6.0-N-E	X3-Hybrid-8.0-N-E	X3-Hybrid-10.0-N-E
X3-Hybrid-5.0-D-E	X3-Hybrid-6.0-D-E	X3-Hybrid-8.0-D-E	X3-Hybrid-10.0-D-E
X3-Hybrid-5.0-N-C	X3-Hybrid-6.0-N-C	X3-Hybrid-8.0-N-C	X3-Hybrid-10.0-N-C
X3-Hybrid-5.0-D-C	X3-Hybrid-6.0-D-C	X3-Hybrid-8.0-D-C	X3-Hybrid-10.0-D-C

Note: **"5.0"** means 5.0kW.

**"D"** means with "DC Switch", **"N"** means without "DC Switch".

**"E"** means "EPS function" will be available with an external changeover device installed.

**"C"** means without "EPS function".

Store this manual where it will be accessible at all times.

## 1.2 Target Group

This manual is for qualified electricians. The tasks described in this manual only can be performed by qualified electricians.

## 1.3 Symbols Used

The following types of safety instructions and general information appear in this document as described below:



**Danger !**  
 "Danger" indicates a hazardous situation which, if not avoided, will result in death or serious injury.



**Warning!**  
 "Warning" indicates a hazardous situation which, if not avoided, could result in death or serious injury.



**Caution !**  
 "Caution" indicates a hazardous situation which, if not avoided, could result in minor or moderate injury.



**Note !**  
 "Note" provides tips that are valuable for the optimal operation of our product.

## 2 Safety

### 2.1 Important Safety Instructions



**Danger!**

**Danger to life due to high voltages in the inverter!**

- All work must be carried out by qualified electrician.
- The appliance is not to be used by children or persons with reduced physical sensory or mental capabilities, or lack of experience and knowledge, unless they have been given supervision or instruction.
- Children should be supervised to ensure that they do not play with the appliance.



**Caution!**

**Danger of burn injuries due to hot enclosure parts!**

- During operation, the upper lid of the enclosure and the enclosure body may become hot.
- Only touch the lower enclosure lid during operation.



**Caution!**

**Possible damage to health as a result of the effects of radiation!**

- Do not stay closer than 20 cm to inverter for any length of time.



**Note!**

**Grounding the PV generator.**

- Comply with the local requirements for grounding the PV modules and the PV generator. It is recommended connecting the generator frame and other electrically conductive surfaces in a manner which ensures continuous conduction and ground these in order to have optimal protection of system and persons.



**Warning!**

- Ensure input DC voltage  $\leq$  Max. DC voltage .Over voltage may cause permanent damage to inverter or other losses, which will not be included in warranty!



**Warning!**

- Authorized service personnel must disconnect both AC and DC power from inverter before attempting any maintenance or cleaning or working on any circuits connected to inverter.



**WARNING !**

Do not operate the inverter when the device is running.



**WARNING !**

Risk of electric shock!

- Prior to the application, please read this section carefully to ensure correct and safe application. Please keep the user manual properly.
- Accessories only together with the inverter shipment are recommended here. Otherwise may result in a risk of fire, electric shock, or injury to person.
- Make sure that existing wiring is in good condition and that wire is not undersized.
- Do not disassemble any parts of inverter which are not mentioned in installation guide. It contains no user-serviceable parts. See Warranty for instructions on obtaining service. Attempting to service the inverter yourself may result in a risk of electric shock or fire and will void your warranty.
- Keep away from flammable, explosive materials to avoid fire disaster.
- The installation place should be away from humid or corrosive substance.
- Authorized service personnel must use insulated tools when installing or working with this equipment.
- PV modules shall have an IEC 61730 class A rating.
- Never touch either the positive or negative pole of PV connecting device. Strictly prohibit touching both of them at the same time.
- The unit contains capacitors that remain charged to a potentially lethal voltage after the MAINS , battery and PV supply has been disconnected. Hazardous voltage will present for up to 5 minutes after disconnection from power supply.
- CAUTION-RISK of electric shock from energy stored in capacitor, Never operate on the inverter couplers, the MAINS cables, Battery cables, PV cables or the PV generator when power is applied. After switching off the PV , battery and Mains, always wait for 5minutes to let the intermediate circuit capacitors discharge before unplugging DC ,battery inplug and MAINS couplers.
- When accessing the internal circuit of inverter, it is very important to wait 45 minutes before operating the power circuit or demounting the electrolyte capacitors inside the device. Do not open the device before hand since the capacitors require time to sufficiently discharge!
- Measure the voltage between terminals UDC+ and UDC- with a multi-meter (impedance at least 1Mohm) to ensure that the device is discharged before beginning work (35VDC) inside the device.



### ► Surge protection devices (SPDs) for PV installation



#### **WARNING !**

Over-voltage protection with surge arresters should be provided when the PV power system is installed. The grid connected inverter is not fitted with SPDs in both PV input side and MAINS side.

Lightning will cause a damage either from a direct strike or from surges due to a nearby strike.

Induced surges are the most likely cause of lightning damage in majority of installations, especially in rural areas where electricity is usually provided by long overhead lines. Surge may be included on both the PV array conduction and the AC cables leading to the building.

Specialists in lightning protection should be consulted during the end use application. Using appropriate external lightning protection, the effect of a direct lightning strike into a building can be mitigated in a controlled way, and the lightning current can be discharged into the ground.

Installation of SPDs to protect the inverter against mechanical damage and excessive stress include a surge arrester in case of a building with external lightning protection system (LPS) when separation distance is kept.

To protect the DC system, surge suppression device (SPD type2) should be fitted at the inverter end of the DC cabling and at the array located between the inverter and the PV generator, if the voltage protection level (VP) of the surge arresters is greater than 1100V, an additional SPD type 3 required for surge protection for electrical devices.

To protect the AC system, surge suppression devices (SPD type2) should be fitted at the main incoming point of AC supply (at the consumer's cutout), located between the inverter and the meter/distribution system; SPD (test impulse D1) for signal line according to EN 61632-1.

All DC cables should be installed to provide as short a run as possible, and positive and negative cables of the string or main DC supply should be bundled together. Avoiding the creation of loops in the system. This requirement for short runs and bundling includes any associated earth bundling conductors.

Spark gap devices are not suitable to be used in DC circuits once conducting, they won't stop conducting until the voltage across their terminals is typically more than 30 volts.

### ► Anti-Islanding Effect

Islanding effect is a special phenomenon that grid-connected PV system still supply power to the nearby grid when the voltage loss is happened in the power system. It is dangerous for maintenance personnel and the public. X3-Hybrid seires inverter provide Active Frequency Drift(AFD) to prevent islanding effect.

### ► PE Connection and Leakage Current

- The end-use application shall monitor the protective conductor by residual current operated protective device (RCD) with rated fault current  $I_{fn} \leq 240\text{mA}$  which automatically disconnects the device in case of a fault.
- DC differential currents are created (caused by insulation resistance and through capacities of the PV generator). In order to prevent unwanted triggering during operation, the rated residual current of the RCD has to be min 240mA.

The device is intended to connect to a PV generator with a capacitance limit of approx 700nf.



#### **WARNING !**

High leakage current!  
Earth connection essential before connecting supply.

- Incorrect grounding can cause physical injury, death or equipment malfunction and increase electromagnetic.
- Make sure that grounding conductor is adequately sized as required by safety regulations.
- Do not connect the ground terminals of the unit in series in case of a multiple installation. This product can cause current with a d.c component, Where a residual current operated protective (RCD) or monitoring (RCM) device is used for protection in case of direct or indirect contact, only an RCD or RCM of type B is allowed on the supply side of this product.

#### **For United Kingdom**

- The installation that connects the equipment to the supply terminals shall comply with the requirements of BS 7671.
- Electrical installation of PV system shall comply with requirements of BS 7671 and IEC 60364-7-712.
- No protection settings can be altered.
- User shall ensure that equipment is so installed, designed and operated to maintain at all times compliance with the requirements of ESQCR22(1)(a).



#### **For Australia and New Zealand**

- Electrical installation and maintenance shall be conducted by licensed electrician and shall comply with Australia National Wiring Rules.









## 2.2 Explanation of Symbols



This section gives an explanation of all the symbols shown on the inverter and on the type label.

### • Symbols on the Inverter

Symbol	Explanation
	Operating Display.
	Battery status.
	An error has occurred, please inform your installer immediately.

### • Symbols on the Type Label

Symbol	Explanation
	CE mark. The inverter complies with the requirements of the applicable CE guidelines.
	TUV certified.
	RCM remark.
	SAA certification.
	Beware of hot surface. The inverter can become hot during operation. Avoid contact during operation.
	Danger of high voltages. Danger to life due to high voltages in the inverter!
	Danger. Risk of electric shock!
	Observe enclosed documentation.

	The inverter can not be disposed together with the household waste. Disposal information can be found in the enclosed documentation.
	Do not operate this inverter until it is isolated from battery, mains and on-site PV generation suppliers.
	Danger to life due to high voltage. There is residual voltage existing in the inverter after powering off, which needs 5 min to discharge. • Wait 5 min before you open the upper lid or the DC lid.

## 2.3 CE Directives

This chapter follows the requirements of the European low voltage directives, which contains the safety instructions and conditions of acceptability for the end user system, which you must follow when installing, operating and servicing the unit. If ignored, physical injury or death may follow, or damage may occur to the unit. Read this instructions before you work on the unit. If you are unable to understand the dangers, warnings, cautions or instructions, please contact an authorized service dealer before installing. Operating and servicing the unit.

The Grid connected inverter meets the requirement stipulated in Low Voltage Directive (LVD) 2014/35/EU and Electromagnetic Compatibility (EMC) Directive 2014/30/EU. The unit is based on:

EN 62109-1:2010 ; EN 62109-2:2011 ; IEC 62109-1(ed.1) ; IEC62109-2(ed.1)  
EN 61000-6-3:2007+A:2011 ; EN 61000-6-1:2007 ; EN 61000-6-2:2005

In case of installation in PV system, startup of the unit (i.e. start of designated operation) is prohibited until it is determined that the full system meets the requirements stipulated in EC Directive (2014/35/EU,2014/30/EU, etc.)

The grid connected inverter leave the factory completely connecting device and ready for connection to the mains and PV supply ,the unit shall be installed in accordance with national wiring regulations. Compliance with safety regulations depends upon installing and configuring system correctly, including using the specified wires. The system must be installed only by professional assemblers who are familiar with requirements for safety and EMC. The assembler is responsible for ensuring that the end system complies with all the relevant laws in the country where it is to be used.

The individual subassembly of the system shall be interconnected by means of the wiring methods outlined in national/international such as the national electric code (NFPA) No.70 or VDE regulation 0107.

### 3. Introduction

#### 3.1 Basic Features

X3-Hybrid Seires is a high-quality inverter which can convert solar energy to AC energy and store energy into battery. Energy produced by inverter can be used to optimize self consumption, store in the battery for future use or feedin to public grid. Work mode depends on PV energy and user's preference. It can provide power for emergency use during the grid lost by using the energy from battery and inverter(generated from PV).

► System Diagram

**E Version** applies to emergency use with external changeover device installed during the grid lost.

E version is designed with two versions for customer to choose based on the local rules.

**Digram A** applies to the wiring rules that requires Live lines and Neutral line of alternative supply must be disconnected after the grid is off. (applies to most countriess)

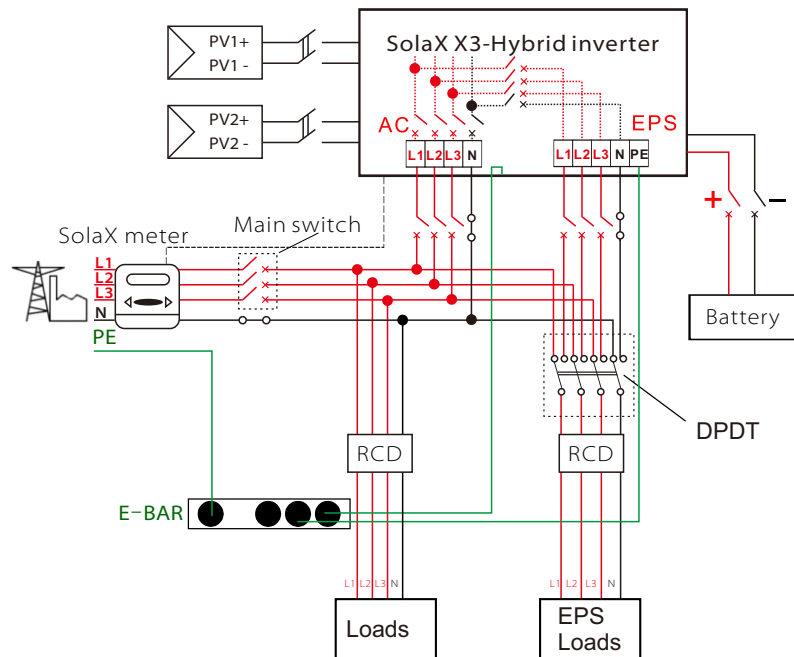

**Digram B** applies to the wiring rules which requires Neutral line of alternative supply must not be isolated or switched. (applies to wiring rules AS/NZS\_3000:2012 for Australia and New Zealand)

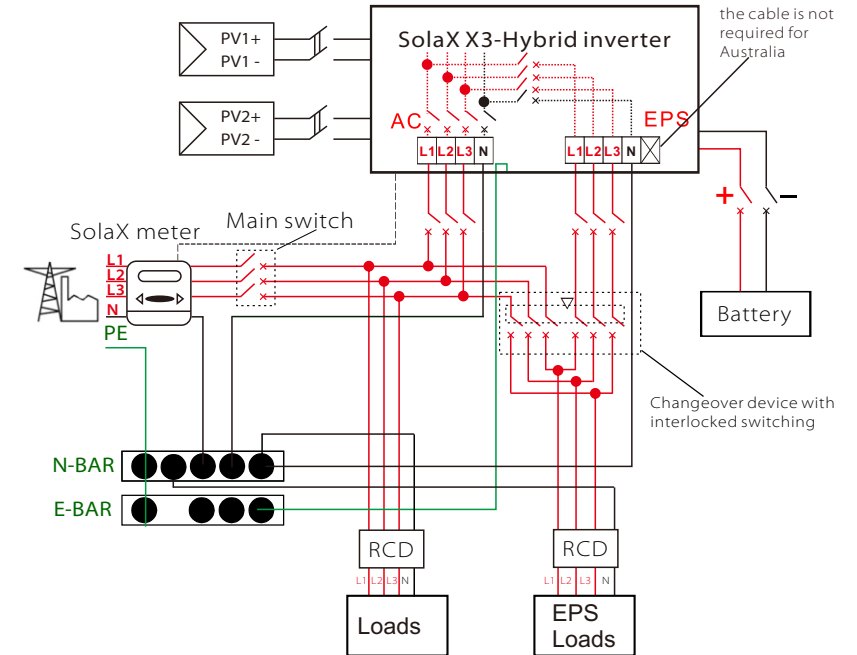

**Note!**

- Please control the home loads, and make sure it's within the "EPS output rating" under EPS mode, otherwise the inverter will shutdown with an "overload fault" warning.
- Please confirm with the mains grid operator whether there is any special regulations for grid connection.

### 3.2 Work Modes

X3-Hybrid Series inverter provides multiple work modes based on different requirements.

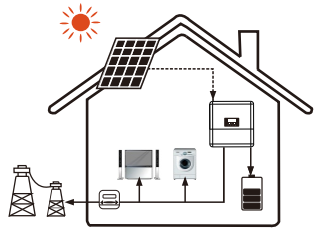

Work modes: **Self-use** (with PV Power)

**Priority: load>battery>grid**

*This mode applies the area that has low feed-in tariff and high energy price.*

The PV generated power will be used to supply the local loads firstly, then to charge the battery. The redundant power will export to the public grid.

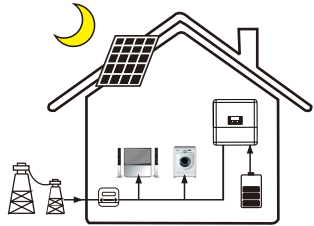

Work modes: **Self-use** (without PV Power)

When there is no PV supplied, battery will discharge for local loads firstly, and grid will supply power when the battery capacity is not enough.

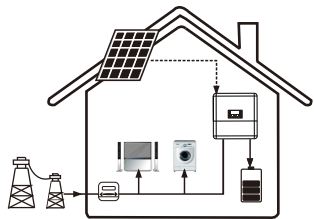

Work modes: **Force time use**

**Priority:battery>load>grid(when charging)**  
**Priority:load>battery>grid(when discharging)**

*This mode applies the area that has electricity price between peak and valley. User can use off-peak electricity to charge the battery.*

The charging time can be set flexibly, and it also allows to choose whether charge from the grid or not.

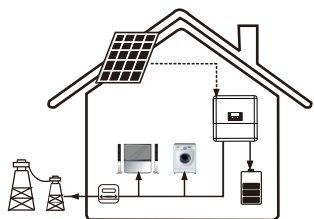

Work modes: **Feed in Priority**

**Priority:load>grid>battery**

*This mode applies the area that has high feed-in tariff and export control.*

The PV generated power will be used to supply the local loads firstly, then export to the public grid. The redundant power will charge the battery.

Work modes: **Back up mode**

**Priority:battery>load>grid**

*This mode applies the area that has frequent power outages. And this mode ensures the battery will has enough energy to supply when the grid is off.*

In this mode battery will be charging forcibly in the setting time and will never be discharged when the grid is on, and it also allows to choose whether charge from the grid or not.

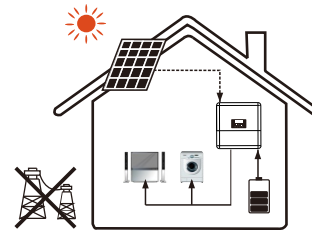
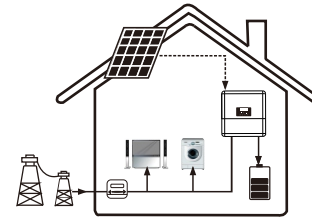

**\* EPS Status**

When the grid is off, system will supply emergency power from PV or battery to supply the home loads. (Battery is necessary in EPS mode.)

### 3.3 Dimension

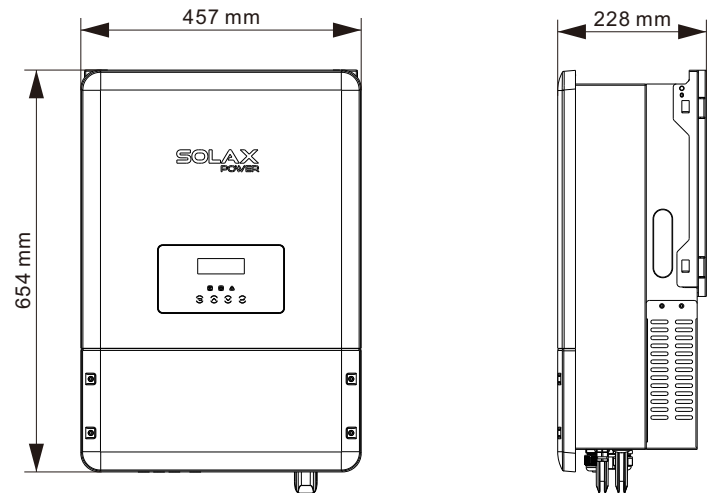

### 3.4 Terminals of PV inverter

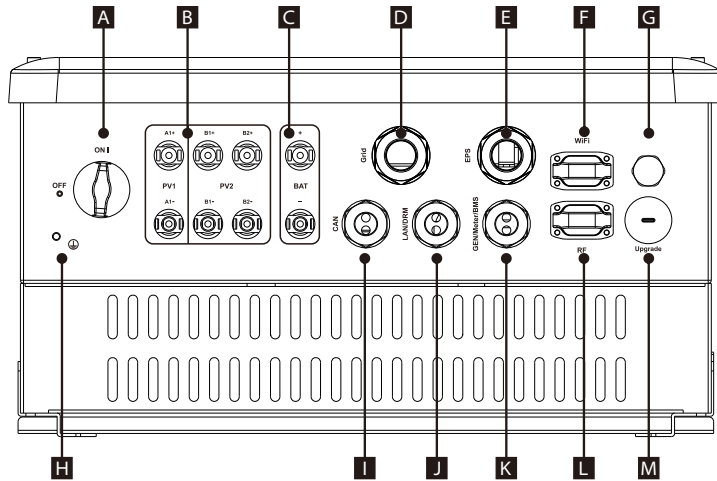

Object	Description
A	DC switch (optional)
B	PV connection area
C	Battery connection area
D	Grid output
E	EPS output
F	WiFi port for external Pocket WiFi
G	Waterproof valve
H	Earthing screw
I	CAN communication port for parallel operation
J	Ethernet port / DRM port
K	Generator communication port/External meter port/ Battery communication port
L	External port for smart plug
M	USB port for upgrading



#### WARNING !

Qualified electrician will be required for the installation.

## 4. Technical Data

### 4.1 DC input

Model	X3-Hybrid-5.0-D	X3-Hybrid-6.0-D	X3-Hybrid-8.0-D	X3-Hybrid-10.0-D
	X3-Hybrid-5.0-N	X3-Hybrid-6.0-N	X3-Hybrid-8.0-N	X3-Hybrid-10.0-N
Max. recommended DC power [W]	A:3000/B:3000	A:4000/B:4000	A:5000/B:5000	A:8000/B:5000
Max. DC voltage[V]	1000	1000	1000	1000
Norminal DC operating voltage[V]	720	720	720	720
MPPT voltage range [V]	200-950	200-950	200-950	200-950
MPPT voltage range[V](full load)	230-800	280-800	370-800	330-800
Max. input current [A]	11/11	11/11	11/11	20/11
Max. short circuit current [A]	14/14	14/14	14/14	23/14
Start input voltage [V]	180	180	180	180
Start output voltage [V]	300	300	300	300
No. of MPP trackers	2	2	2	2
Strings per MPP tracker	A:1/B:1	A:1/B:1	A:1/B:1	A:2/B:1
DC disconnection switch	optional			

### 4.2 AC output/input

Model	X3-Hybrid-5.0-D	X3-Hybrid-6.0-D	X3-Hybrid-8.0-D	X3-Hybrid-10.0-D
	X3-Hybrid-5.0-N	X3-Hybrid-6.0-N	X3-Hybrid-8.0-N	X3-Hybrid-10.0-N
<b>AC output</b>				
Norminal AC power[VA]	5000	6000	8000	10000
Max. apparent AC power[VA]	5000	6000	8000	10000
Rated grid voltage(range)[V]	400V/230VAC;380V/220VAC			
Rated grid frequency[Hz]	50/60			
Norminal AC current[A](@230VAC)	7.2	8.7	11.6	14.5
Max.AC current[A]	8.0	9.6	12.8	16.0
Displacement power factor	0.8 leading...0.8 lagging			
Total harmonic distortion(THDi)	< 2%			
Load control	Being developed			
<b>AC input</b>				
Norminal AC power[VA]	5000	6000	7000	7000
Rated grid frequency[Hz]	50/60			
Rated grid frequency(range)[Hz]	47...53/57...63			
Norminal AC current[A](@230VAC)	7.2	8.7	10.1	10.1
Max.AC current[A]	8.0	9.6	11.2	11.2
Rated grid voltage(range)[V]	400V/230VAC;380V/220VAC			
Displacement power factor	0.8 leading...0.8 lagging			

### 4.3 Internal Charger

Model	X3-Hybrid-5.0-D	X3-Hybrid-6.0-D	X3-Hybrid-8.0-D	X3-Hybrid-10.0-D
	X3-Hybrid-5.0-N	X3-Hybrid-6.0-N	X3-Hybrid-8.0-N	X3-Hybrid-10.0-N
Battery type	Lithium battery			
Battery voltage range[V]	170-500			
Max. charge/discharge power[W]	6000	8000	10000	10000
Max. charge/discharge current[A]	25A			
Peak charge/discharge current[A]	30A, 60s			
Communication interfaces	CAN/RS485			
Reverse connect protection	Yes			

### 4.4 Efficiency, Safety and Protection

Model	X3-Hybrid-5.0-D	X3-Hybrid-6.0-D	X3-Hybrid-8.0-D	X3-Hybrid-10.0-D
	X3-Hybrid-5.0-N	X3-Hybrid-6.0-N	X3-Hybrid-8.0-N	X3-Hybrid-10.0-N
MPPT efficiency	99.90%	99.90%	99.90%	99.90%
Euro efficiency	97.00%	97.00%	97.00%	97.00%
Max. efficiency	97.80%	97.80%	97.80%	97.80%
Max. battery charge/discharge efficiency	97.60%/96.00%	97.60%/96.00%	97.60%/96.00%	97.60%/96.00%
<b>Safety &amp; Protection</b>				
Over/under voltage protection	YES			
DC isolation protection	YES			
Monitoring ground fault protection	YES			
Grid protection	YES			
DC injection monitoring	YES			
Back feed current monitoring	YES			
Residual current detection	YES			
Anti-islanding protection	YES			
Over load protection	YES			
Over heat protection	YES			

### 4.5 EPS output ( apply to version E only)

Model	X3-Hybrid-5.0-D	X3-Hybrid-6.0-D	X3-Hybrid-8.0-D	X3-Hybrid-10.0-D
	X3-Hybrid-5.0-N	X3-Hybrid-6.0-N	X3-Hybrid-8.0-N	X3-Hybrid-10.0-N
EPS rated power[VA]	5000	6000	8000	10000
Max. EPS power[VA]	5000	6000	8000	10000
EPS rated voltage[v]	400V/230VAC, 380V/220VAC			
EPS rated current[A](@230VAC)	7.2	8.7	11.6	14.5
EPS peak power[W]	10000,60s	12000,60s	14000,60s	14000,60s
Switch time[s]	<2s			
Total harmonic distortion(THDv)	<2%			
Parallel operation	Being developed			
Compatible with the generator	Being developed			

### 4.6 General Data

Model	X3-Hybrid-5.0-D	X3-Hybrid-6.0-D	X3-Hybrid-8.0-D	X3-Hybrid-10.0-D
	X3-Hybrid-5.0-N	X3-Hybrid-6.0-N	X3-Hybrid-8.0-N	X3-Hybrid-10.0-N
Dimension (W/H/D)[mm]	654*457*228			
Dimension of packing (W/H/D)[mm]	777*567*423			
Net weight [kg]	45	45	45	45
Gross weight [kg]	48	48	48	48
Installation	Wall-mounted			
Operating temperature range[°C]	-20~+60 (derating at 45)			
Storage temperature [°C]	-20~+60			
Storage/Operation relative humidity	0%~100%, condensing			
Altitude [m]	<2000			
Ingress Protection	IP65(for outdoor use)			
Standby consumption[W]	<7			
Idle mode	YES			
Over Voltage Category	III(MAINS), II(PV,Battery)			
cooling	Natural			
Inverter Topology	Transformerless			
Communication interface	Ethernet, Meter, WIFI(optional), RF(optional), DRM, USB, ISO alarm			
LCD display	Backlight 20*4 character			
Standard warranty	Standard 5 years(10 years optional)			

## 5. Installation

### 5.1 Check for Physical Damage

Make sure the inverter is intact during transportation. If there is any visible damage, such as cracks, please contact your dealer immediately.

### 5.2 Packing List

Open the package and take out the product, please check the accessories first. The packing list shown as below.

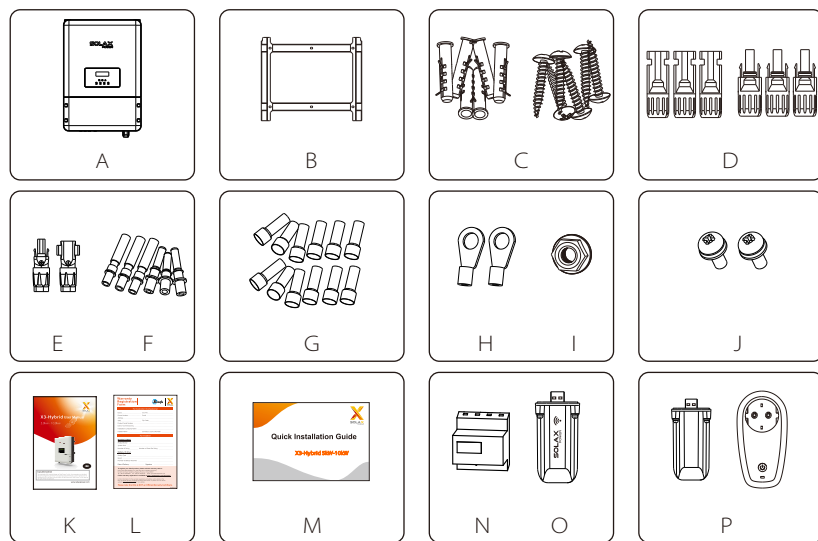

Object	Description
A	Inverter
B	Bracket
C	Expansion tubes & Expansion screws (6/6)
D	PV connectors (3*positive, 3*negative)
E	Battery connectors (1*positive, 1*negative)
F	PV pin connectors (3*positive, 3*negative)
G	AC terminals/EPs terminals (optional)/Earth terminals (12)

Object	Description
H	Ring terminal (for grounding) (2)
I	Grounding nut
J	Set screw (2)
K	User manual
L	Warranty card
M	Quick installation guide
N	Three-phase meter
O	Wifi module (optional)
P	Smart Plug (optional)

### 5.3 Mounting

#### ➤ Installation Precaution

X3-Hybrid Series inverter is designed for outdoor installation (IP 65). Make sure the installation site meets the following conditions:

- Not in direct sunlight.
- Not in areas where highly flammable materials are stored.
- Not in potential explosive areas.
- Not in the cool air directly.
- Not near the television antenna or antenna cable.
- Not higher than altitude of about 2000m above sea level.
- Not in environment of precipitation or humidity (>95%).
- Under good ventilation condition.
- The ambient temperature in the range of -20°C to +60°C.
- The slope of the wall should be within  $\pm 5^\circ$ .
- The wall hanging the inverter should meet conditions below:
  1. solid brick/concrete, or strength equivalent mounting surface;
  2. Inverter must be supported or strengthened if the wall's strength isn't enough (such as wooden wall, the wall covered by thick layer of decoration)

Please AVOID direct sunlight, rain exposure, snow laying up during installation and operation.

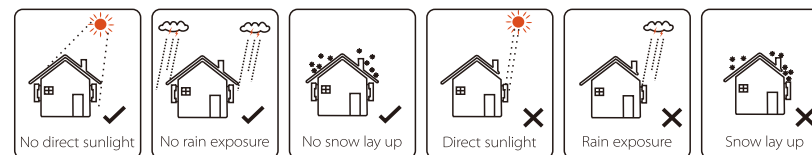

➤ Space Requirement

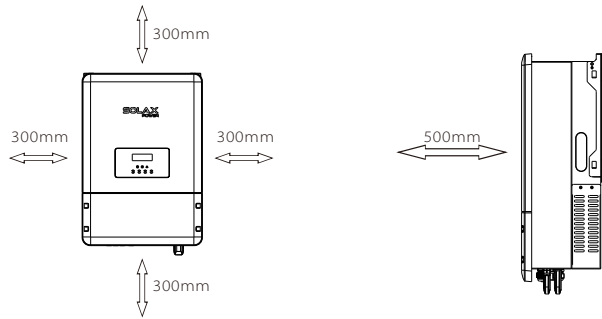

➤ Mounting Steps

Tools required for installation.

Installation tools : crimping pliers for binding post and RJ 45, screwdriver, manual wrench and  $\varnothing 10$  driller.



Step 1: Screw the wall bracket on the wall

- 1.1 Place the bracket on the wall and mark down the position of the 6 holes.
- 1.2 Drill holes with driller, make sure the holes are deep enough (at least 60mm) to support the inverter.
- 1.3 Install the expansion tubes in the holes, and tighten them. Then install the wall bracket with the expansion screws.

Step 2: Place the inverter on the wall mounted bracket by holding the handle on the side.

Step 3: Screw the set screw on the right-top of inverter tightly.

Step 4: If necessary, customer can install an anti-theft lock on the right-top of the inverter.

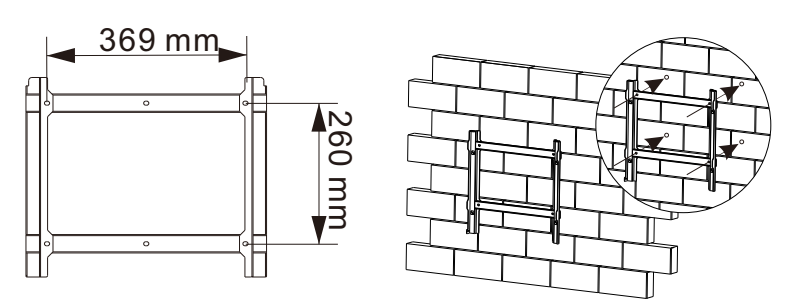

Step 1

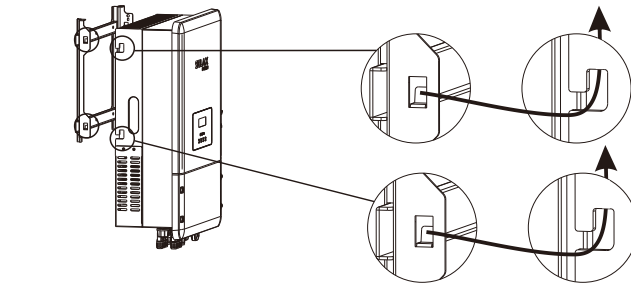

Step 2

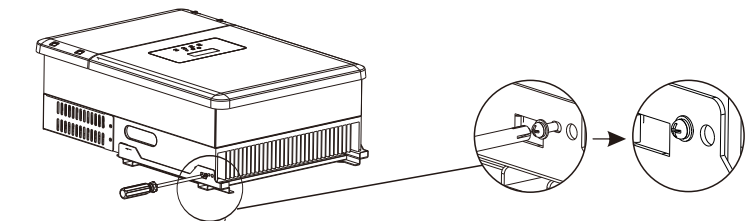

Step 3

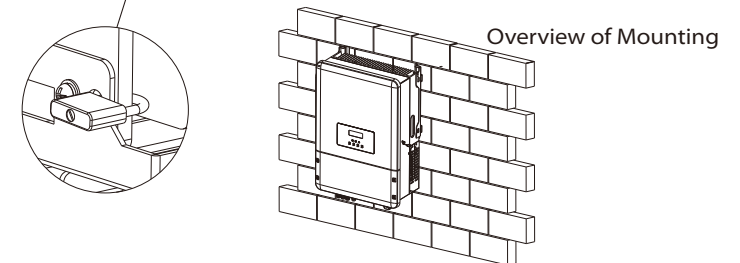

Step 4



## 6. Electrical Connection

### 6.1 PV Connection

X3-Hybrid can be connected with PV modules in series with 2 MPPTs for 5.0KW, 6.0KW, 8.0KW and 10.0KW.

Select PV modules with excellent function and reliable quality. Open-circuit voltage of module arrays connected in series should be under Max. DC input voltage; operating voltage should be conformed to MPPT voltage range.

Max.DC Voltage Limitation

Model	X3-Hybrid-5.0-D	X3-Hybrid-6.0-D	X3-Hybrid-8.0-D	X3-Hybrid-10.0-D
	X3-Hybrid-5.0-N	X3-Hybrid-6.0-N	X3-Hybrid-8.0-N	X3-Hybrid-10.0-N
Max. DC Voltage (V)	1000			
MPPT Voltage Range(V)	200-950			



**Warning!**

- PV module voltage is very high, which already achieve dangerous voltage range, please comply with electric safety rules when connecting.
- Please do not make PV positive or negative ground!



**Note!**

- Please choose a fitting external DC switch if the model (X3-Hybrid-5.0-N, X3-Hybrid-6.0-N, X3-Hybrid-8.0-N, X3-Hybrid-10.0-N) is purchased.
- The following requirements of PV modules need to be applied for each input area;
  - Same type
  - Same quantity
  - Identical alignment
  - Identical tilt
 Please do not make PV positive or negative ground!
- In order to save cable and reduce the DC loss, we suggest to install the inverter near PV modules.



**Note!**

PV connection mode below is NOT allowed!

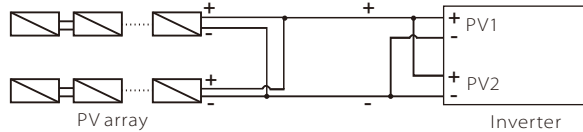

### Connection Steps:

**Step1. Checking PV module.**

- 1.1 Use multimeter to measure module array voltage.
- 1.2 Check the PV+ and PV- from the PV string combiner box correctly.
- 1.3 Please make sure the impedance between the positive pole and negative pole of PV to earth should be MΩ level.

**Step2. Separating the DC connector.**

**Step3. Wiring.**

- 3.1 Choose the 12 AWG wire to connect with the cold-pressed terminal.
- 3.2 Remove 10mm of insulation from the end of wire.
- 3.3 Insert the insulation into pin contact and use crimping plier to clamp it.

**Step4. Insert pin contact through the cable nut to assemble into back of the male or female plug. When you feel or heard a "click" sound the pin contact assembly is seated correctly.**

**Step5. Plug the PV connector into the corresponding PV connector on inverter.**

**Step2.**

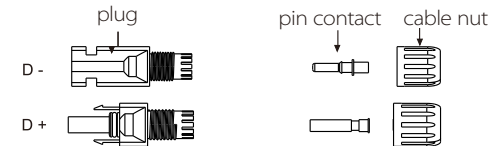

**Step3.**

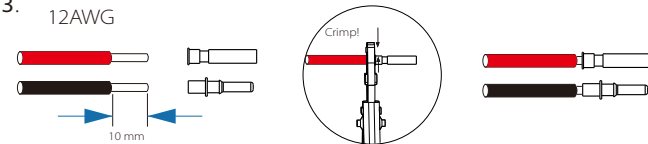

**Step4.**

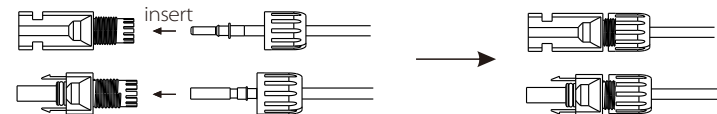

**Step5.**

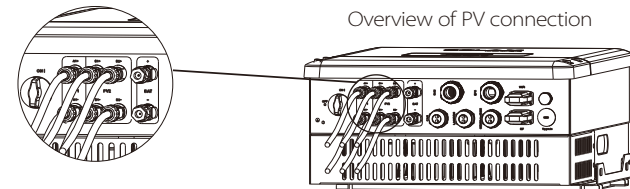

## 6.2 Grid Connection

X3-Hybrid series inverter are designed for three phase grid. Voltage is 380/400V, frequency is 50/60Hz. Other technical requests should comply with the requirement of the local public grid.

Table 4 Cable and Micro-breaker recommended

Model	X3-Hybrid-5.0-D	X3-Hybrid-6.0-D	X3-Hybrid-8.0-D	X3-Hybrid-10.0-D
	X3-Hybrid-5.0-N	X3-Hybrid-6.0-N	X3-Hybrid-8.0-N	X3-Hybrid-10.0-N
Cable	4-5mm <sup>2</sup>	4-5mm <sup>2</sup>	4-5mm <sup>2</sup>	5-6mm <sup>2</sup>
Micro-breaker	20A	20A	25A	32A

Micro-breaker should be installed between inverter and grid, any load should not be connected with inverter directly.

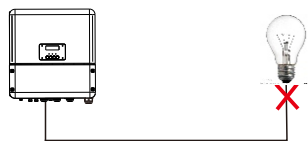

Incorrect Connection between Load and Inverter

### Connection Steps:

#### Step1. Check the grid voltage.

- 1.1 Check the grid voltage and compare with the permissive voltage range (Please refer to technical data).
- 1.2 Disconnect the circuit-breaker from all the phases and secure against re-connection.

#### Step2. Remove the down-top cover from the inverter.

#### Step3. Make AC wires.

- 3.1 Choose the appropriate wire(Cable size: refer to Table 4).
- 3.2 Reserve about 60mm of conductor material sectional area.
- 3.3 Remove 12mm of insulation from the end of wire.
- 3.4 Insert stripped wires into AC terminal and insure all conductor strands are captured in the AC terminal.
- 3.5 Compress the AC terminal head by using a crimping pliers and screw down screw cap tightly.

**Step4.** Insert AC cable into Grid port through screw cap and then tighten the screw cap. Insert L1,L2,L3 wire and N wire into corresponding ports of AC terminal. Compress the PE wire with earth terminal, then screw it on the grounding stud.

#### Step2.

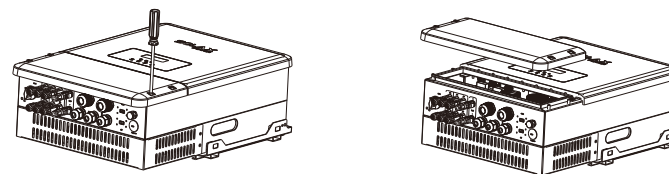

#### Step3.

Cable Size: Refer to Tabel 4(page 24)

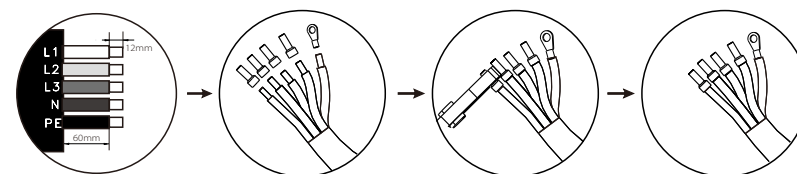

#### Step4.

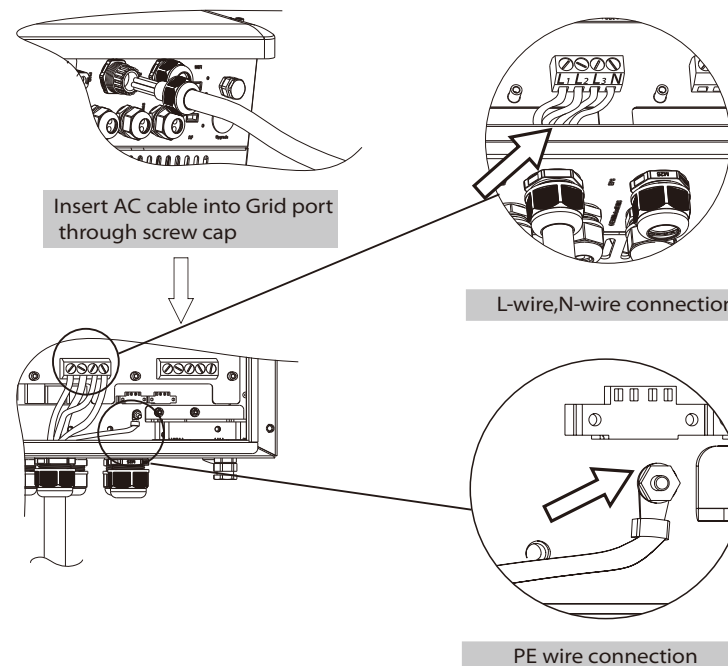

### 6.3 EPS Connection( apply to E Version)

X3-Hybrid series inverter has On and Off grid function, the inverter will deliver output power through AC port when the grid is on, and it will deliver output power through EPS port when the the grid is off.

This function can be achieved manually or automatically according to user's preference. If user wants to use the off grid function manually, it will need to be installed an external switch. Please refer to specific wiring diagram below or as described in quick installation guide.

For automatical solution, please contact our sales.

#### ➤ EPS wiring diagram

The below diagram are for reference based on different local wiring rules, please follow the local rules for the external wiring to choose suitable wiring mode.

**Diagram A** : Neutral line of alternative supply must not be isolated or switched.

**Diagram B** : Neutral line of alternative supply can be isolated or switched.

Digram A • E Version • For AU/NZ

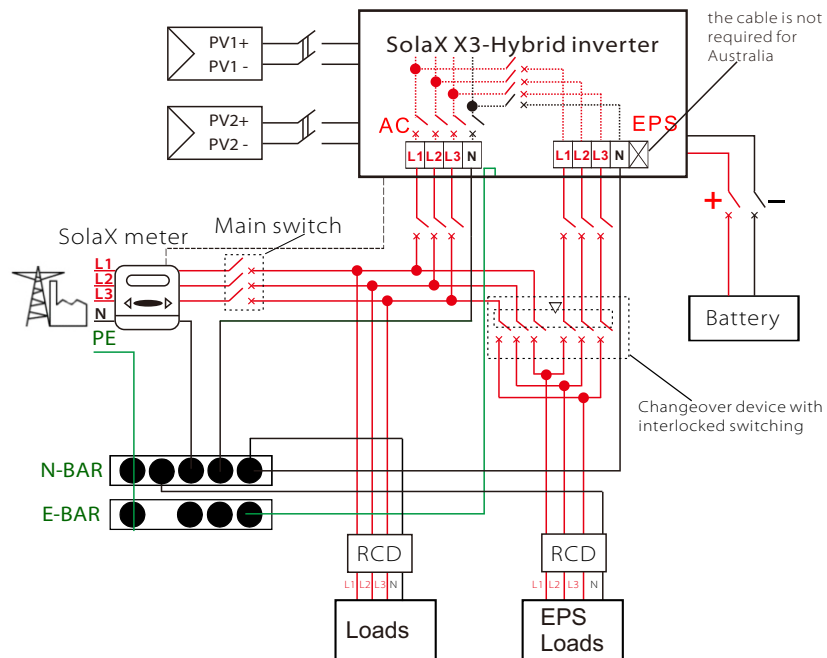

Digram B • E Version • For Other Countries

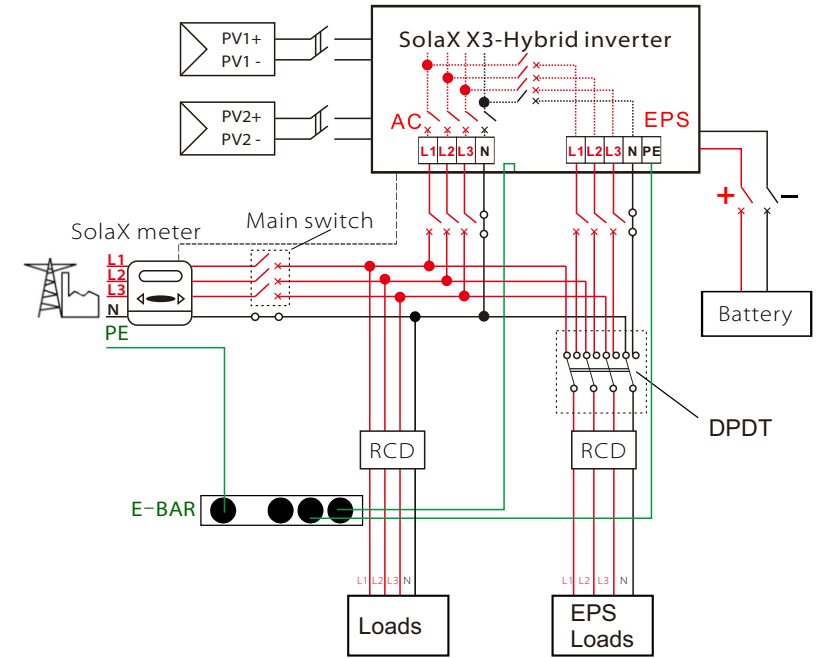

Please contact our sales for any compatible contactor purchase requirement .



**Note!**

In case of discrepancies between wiring mode of local policy and the operation guide above, especially for the wiring of neutral line, grounding and RCD, please contact us before any operation!

➤ Connection Steps:

**Step1.** Make EPS wires.

- 3.1 Choose the appropriate wire (cable size: refer to picture below).
- 3.2 Reserve about 60mm of conductor material sectional area.
- 3.3 Remove 12mm of insulation from the end of wire.
- 3.4 Insert stripped wires into AC terminal and insure all conductor strands are captured in the AC terminal.
- 3.5 Compress the AC terminal head by using a crimping pliers and screw down screw cap tightly.

**Step2.** Insert EPS cable into EPS port through screw cap and then tighten the screw cap. Insert L1,L2,L3 wire, N wire and PE wire (PE wire does not applies to Australia) into corresponding ports of EPS terminal and screw them tightly.

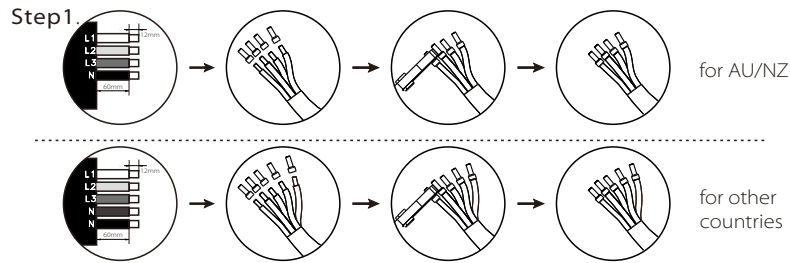
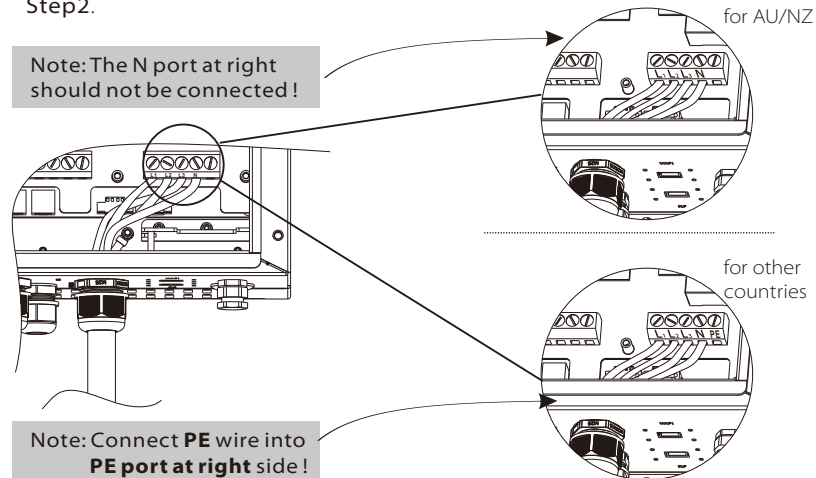

Table 5 Cable and Micro-breaker recommended

Model	X3-Hybrid-5.0-D X3-Hybrid-5.0-N	X3-Hybrid-6.0-D X3-Hybrid-6.0-N	X3-Hybrid-8.0-D X3-Hybrid-8.0-N	X3-Hybrid-10.0-D X3-Hybrid-10.0-N
EPS Cable	≥5mm <sup>2</sup>	≥5mm <sup>2</sup>	≥5mm <sup>2</sup>	≥5mm <sup>2</sup>
EPS breaker	25A	25A	32A	32A

**Step2.**



➤ Requirements for EPS load



**WARNING !**

Make sure the EPS load power rating is within EPS output rating, otherwise the inverter will shutdown with an "over load" warning.

When an "over load" is appeared, adjust the load power to make sure it is within the EPS output power range, then turn the inverter back on.

For the nonlinear load, please make sure the inrush power should be within the EPS output power range.

Below table shows some common feasible loads for you reference.

Type	Power		Common equipment	Example		
	Start	Rated		Equipment	Start	Rated
Resistive load	X 1	X 1	Incandescent lamp TV	Incandescent lamp 100W	100VA (W)	100VA (W)
Capacitive load	X 2	X 1.5	Fluorescent lamp	Fluorescent lamp 40W	80VA (W)	60VA (W)
Inductive load	X 3~5	X 2	Fan Fridge	Fridge 150W	450-750VA (W)	300VA (W)

### 6.4 Battery Connection

Charging & discharging system of X3-Hybrid series inverter is designed for **high-voltage lithium battery**. Before choosing battery, please note the maximum voltage of battery can not exceed **500V** and the rated voltage of battery can not exceed **400V**, and the battery communication should be compatible with X3-Hybrid inverter.

#### ➤ Battery breaker

Before connecting to battery, please install a nonpolarized DC breaker to make sure inverter can be securely disconnected during maintenance.

Model	X3-Hybrid-5.0-D X3-Hybrid-5.0-N	X3-Hybrid-6.0-D X3-Hybrid-6.0-N	X3-Hybrid-8.0-D X3-Hybrid-8.0-N	X3-Hybrid-10.0-D X3-Hybrid-10.0-N
Voltage	Nominal voltage of DC breaker should be larger than maximum voltage of battery.			
Current[A]	32A			

#### ➤ Battery connection diagram

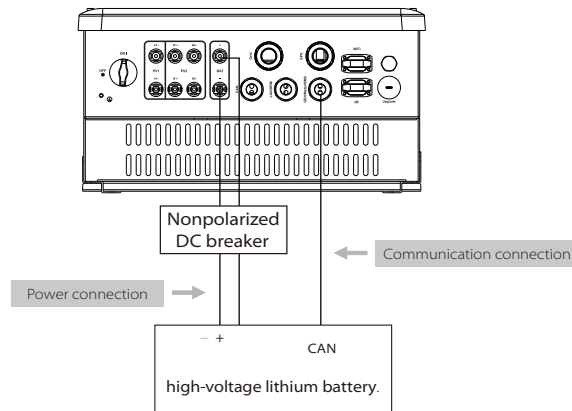

#### ➤ BMS PIN Definition

Communication interface between inverter and battery is CAN with a RJ45 connector.

PIN	1	2	3	4	5	6	7	8
Definition	X	GND	X	BMS_CANH	BMS_CANL	GND	BMS_485A	BMS_485B



**Note!**  
The battery communication can only work when the battery BMS is compatible with the inverter.

#### ➤ Power Connection Steps:

- Step1.** Choose the 9 AWG wire and strip the cable to 15mm.
- Step2.** Insert the stripped cable up to the stop ( negative cable for DC plug(-) and positive cable for DC socket(+)) are live). Hold the housing on the screw connection.
- Step3.** Press down spring until it clicks audibly into place.(it must be possible to see the fine wire strands in the chamber)
- Step4.** Tighten the screw connection(tighten torque:2.0Nm)
- Step5.** Plug the PV connector into the corresponding PV connector on inverter.

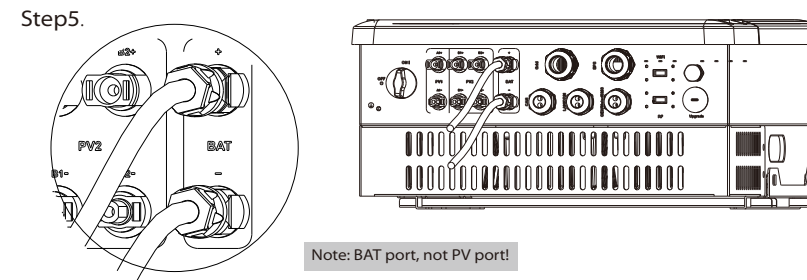
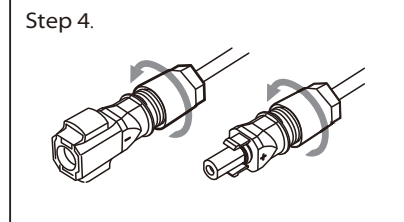
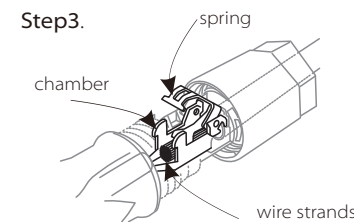
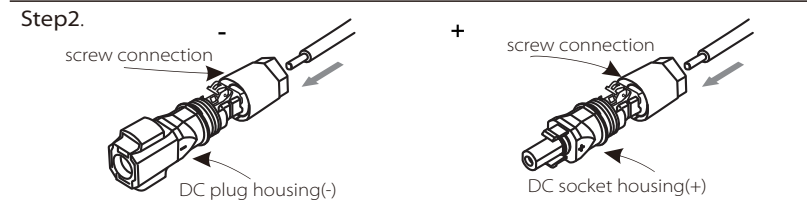

Note: BAT port, not PV port!

Note: The positive line and negative line are not allowed to access anti-Line.

➤ **Communication Connection Steps:**

**Step1.** Disassemble the GEN/Meter/BMS cable gland.

**Step2.** Prepare a communication cable(without sheath) and insert the communication cable through the cable nut.

**Step3.** Assemble the cable gland and screw the cable nut.

**Step4.** Insert one RJ45 side of the cable into BMS port inside of inverter and the other side into RS485 or Can port of the battery.

Step1,2

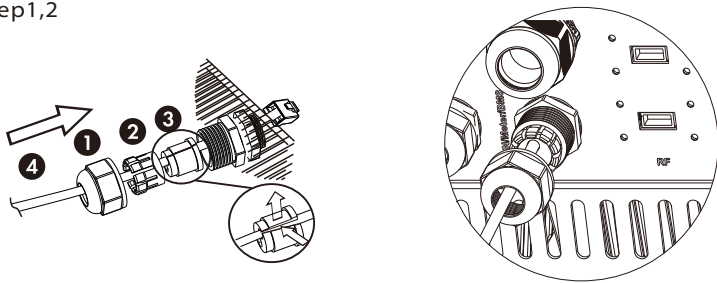

Step3

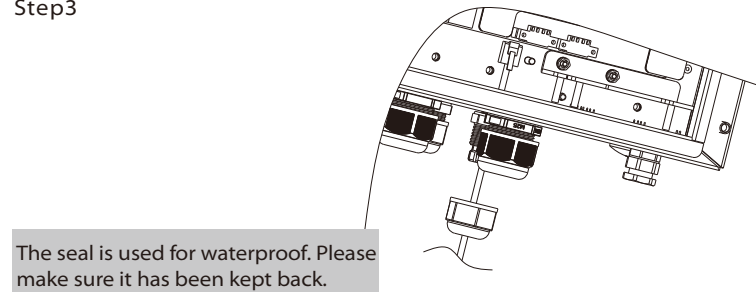

Step4

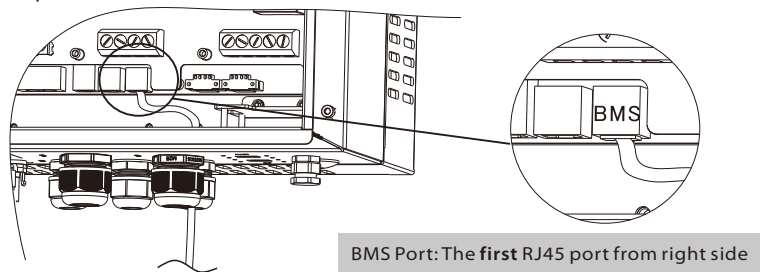

**6.5 Earth Connection(mandatory)**

User can additionally earth the inverter to the enclosure of a second earthing or equipotential bonding if it is required by local safety. This prevents electric shock if the original protective conductor fails.

➤ **Earth Connection Steps:**

**Step1.** Strip the earthing cable insulation and insert the stripped cable into the ring terminal, then clamp it .

**Step2.** Place the ring terminal into the earthing rod and screw the earthing screw tightly.

Step1

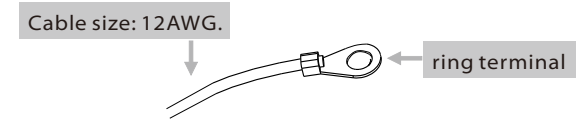

Step2

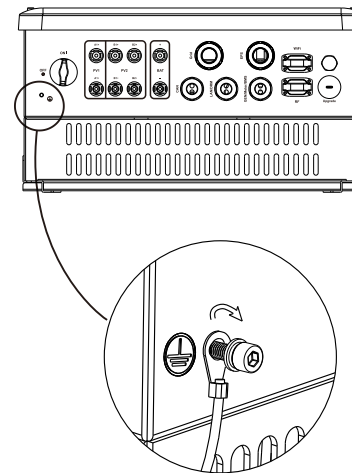

## 6.6 Meter Connection

Meter is used for monitoring the power usage for entire house, at the meantime, inverter will also need the data from Meter to achieve the Export Control Function.

**Note!**  
 It is necessary to connect meter to inverter otherwise inverter will shutdown with a "Meter fault" alert.  
 The meter communication only works when meter is compatible with the inverter.

### ➤ Meter connection diagram

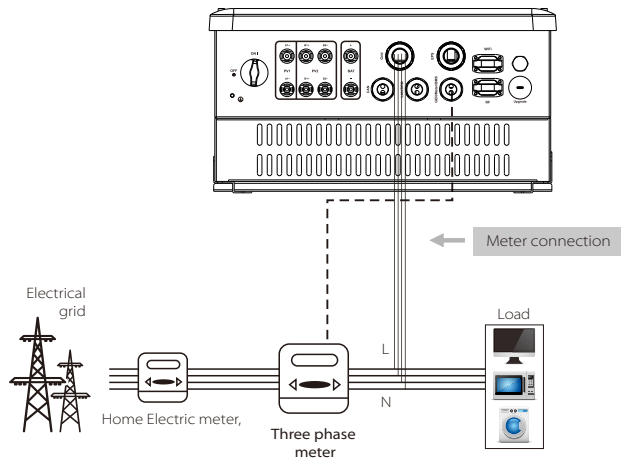

### ➤ Meter Interface

Communication interface between inverter and meter is RS485 with two wires.

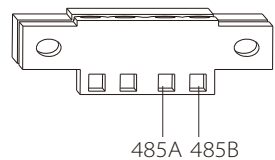

### ➤ Meter Connection Steps:

Please kindly note the PIN definition and port position.

**Step1.** Prepare a connector and two communication wires.

**Step2.** Unscrew the nut of Meter connector and insert two communication wires through it.

**Step3.** Strip the insulation from the communication wires, then insert one side of wires into connector ports.

**Step4.** Insert connector into Meter terminal inside of the inverter. Insert the other side of wires into corresponding meter ports.

Step1

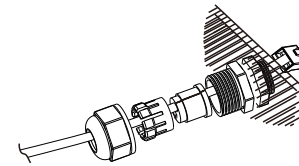

Step2

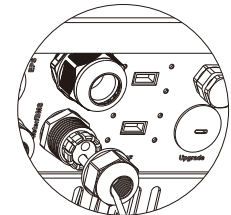

Step3

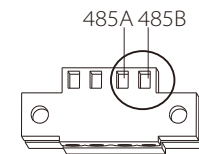
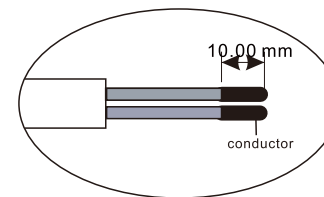

Step4

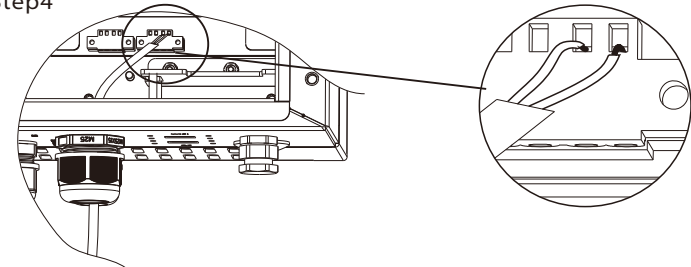

### 6.7 LAN Connection

LAN communication is the standard communication interface. It can transmit the data between the router and inverter via the local network.

#### ➤ Application Occasion

This function is applicable for the below situation:  
 When the wifi signal is too weak to transmit data, user can use LAN port for the monitoring with a data cable.  
 Note: The wifi module can still be connected when using LAN connection.

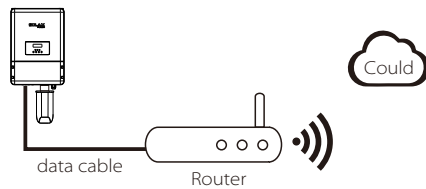

#### ➤ LAN PIN Definition

Communication interface between inverter and router is RS485 with a RJ45 connector.

	1	2	3	4	5	6	7	8
	TX+	TX-	RX+	X	X	RX-	X	X

#### ➤ LAN Connection Steps:

Please refer to BMS connection steps (page32) for LAN connection. Please kindly noted the PIN definition and port position will be slightly different.

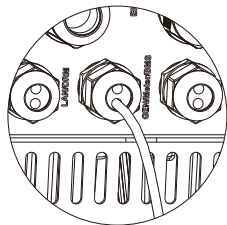

LAN/DRM Port

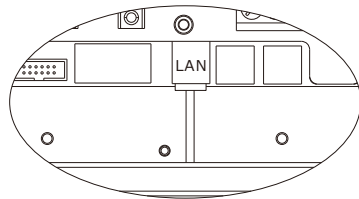

LAN Port: The **Third** RJ45 port from right side

### 6.8 DRM Connection

DRM is provided to support several demand response modes by emitting control signals as below.

*Note: Only PIN6(DRM0) can be work for now, and other PIN functions are being developed.*

	1	2	3	4	5	6	7	8
	DRM1/5	DRM2/6	DRM3/7	DRM4/8	+3.3V	DRM0	GND	GND

#### ➤ DRM Connection Steps:

Please refer to BMS connection steps (page32) for DRM connection. Please kindly noted the PIN definition and port position will be slightly different.

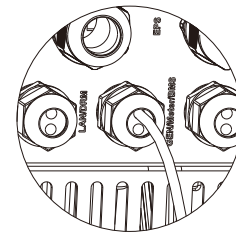

LAN/DRM Port

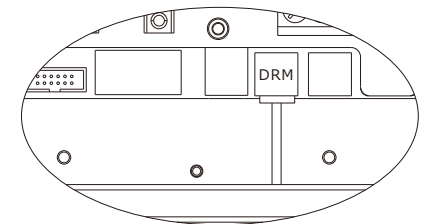

DRM Port: The **second** RJ45 port from right side



### 6.9 WiFi Connection(optional)

Inverter provides a WiFi port which can collect data from inverter and transmit it to monitoring-website via a Pocket WiFi.(Purchase the product from supplier if needed)

➤ Diagram

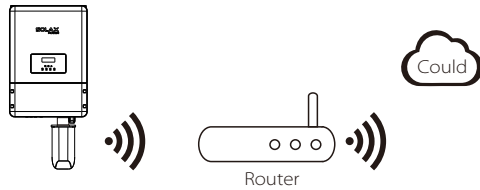

➤ WiFi Connection Steps:

- Step1.** Plug Pocket Wifi into “WiFi” port at the bottom of the inverter.
- Step2.** Build the connection between the inverter and router.
- Step3.** Create an user account online.( Please check the Pocket WiFi user manual for more details.)

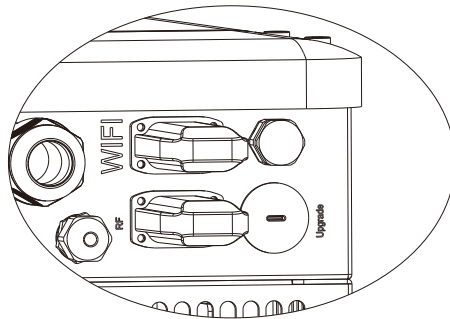

### 6.10 RF Connection(optional)

X3-Hybrid inverter provides a RF( radio frequency) interface which control the switch time of a designated load via an external Smart Plug (purchase the product from supplier if needed.) so that the load mostly consumes PV energy and incurs the lowest-possible energy costs during operation.

➤ Diagram

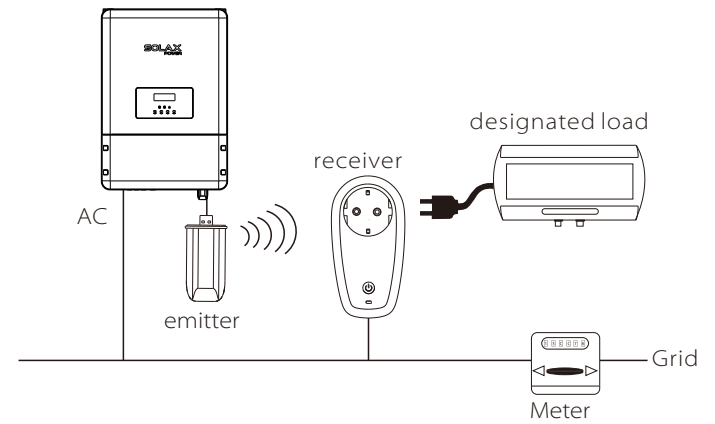

➤ RF Connection Steps:

Please refer to the Smart Plug user manual for detailed connection steps.

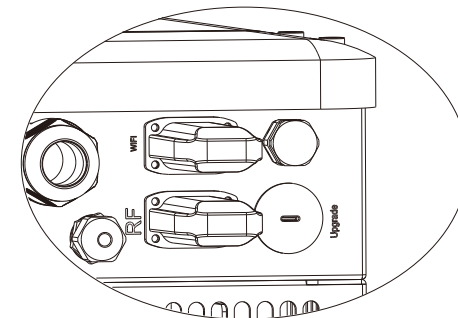

## 6.11 Inverter Manipulation

### ➤ Start inverter after checking all below steps:

- ❶ Check whether the inverter is fixed well on the wall.
- ❷ Make sure all the DC wirings and AC wirings are completed.
- ❸ Make sure the meter is connected well.
- ❹ Make sure the battery is connected well.
- ❺ Make sure the external EPS contactor is connected well. (if needed)
- ❻ Turn on the DC switch at the bottom of the inverter to "ON" position.
- ❼ Turn on the external DC and external AC switch.

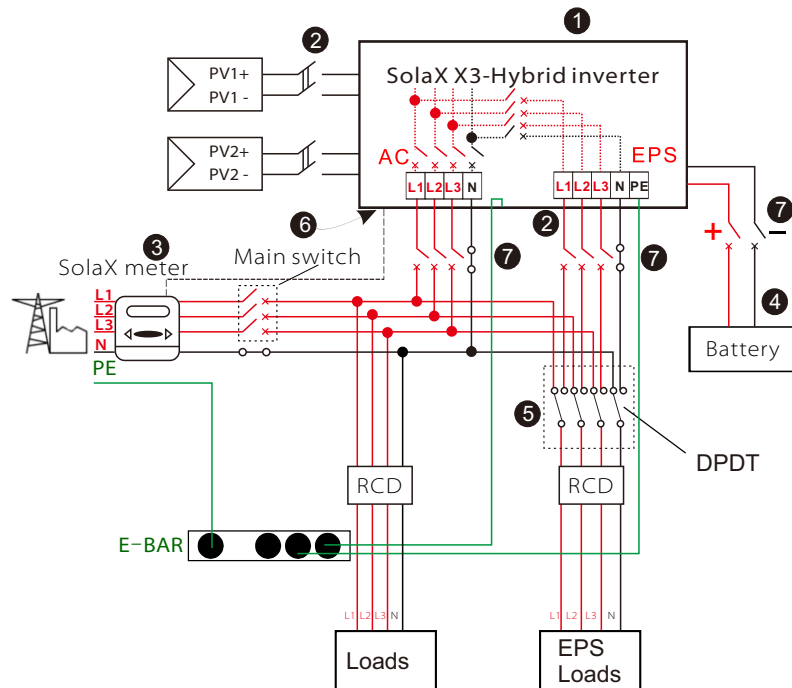

### ➤ Start inverter after checking all below steps:

**Step1.** Inverter will start up automatically when the PV panels generate enough energy or the battery is discharging.

**Step2.** Check the status of indicators and LCD screen. The left indicator should be blue and the indicator screen should display the main interface.



#### Note !

If the left indicator is not blue please check below points:

- All the connection are correct.
- All the external breakers are switched on.
- The DC switch on the inverter is in the "ON" position.

**Step3.** There is a setting guide on the LCD screen if it is the first time to start up, pls follow it. For specific setting, please refer to section 8 (Setting).

**Step4.** Set WiFi according to wifi user manual.

**Step5.** Operate "Self Test". (if needed)

### ➤ Self-test in accordance with CEI 0-21 (applies to Italy only)

The self-test is only required for inverters, which are commissioned in Italy. The Italian standard requires that all inverters feeding into the utility grid are equipped with a self-test function in accordance with CEI 0-21. During the self-test, the inverter will consecutively check the protection reaction times and values for overvoltage, undervoltage, overfrequency and underfrequency.

Selftest function is available at any time, and the test report will show on the LCD display for end-user.

## 7. Firmware Upgrading

User can upgrade inverter’s firmware via an U-disk.

### ➤ Preparation

Please ensure the inverter is steadily powered on.  
 Inverter must connect PV panels and keep the battery on through whole procedure of upgrading.  
 Please prepare a PC and an U-disk.



**Warning!**

Make sure the PV input power is more than 180V (**operate the upgrade on a sunny day**), otherwise it may result in **serious failing** during upgrading.

### ➤ Upgrading Steps:

**Step1.** Please contact our service support to get the update files, and extract it into your U-disk as follow:

*"update\ARM\618.00098.00\_Hybrid\_X3G3\_Manager\_VX.XX\_XX-XX.usb";*

*"update\DSP\Hybrid\_G3X3\_Master.hex";*

*(Vx.xx is version number, xxxxxxxx is file completion date)*



**Warning!**

Make sure the directory is in accordance with above form strictly!  
 Do not modify the program file name, or it may cause the inverter is fail to upgrade!

**Step2.** Turn off the DC switch ,AC breaker, EPS breaker and battery. Then unscrew the waterproof lid and insert U-disk into the “upgrade” port at the bottom of the inverter.

**Step3.** Turn on DC switch and battery , the LCD will be shown as picture 3-1. Then press up and down to select the one that you want to upgrade and press “OK” to confirm to upgrade.

**Step4.** After the upgrade is finished, please remember to turn off the DC switch and battery, then pull off the U-disk and screw the waterproof lid. After each upgrade, inverter is in “off mode”. Please switch the system switch to “ON”.

### Step2

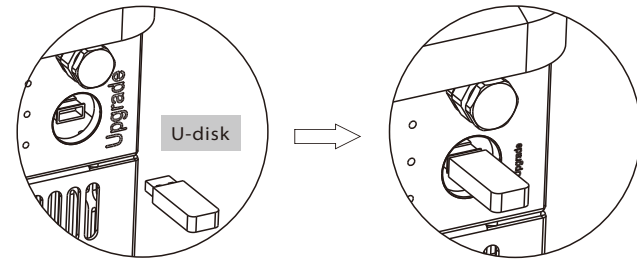

### Step3

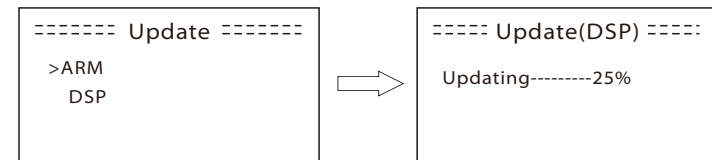

**Warning!**

If the upgrading is broken off during operation, please ensure the inverter is steadily powered on and reinsert the U-disk.

# 8. Setting

## 8.1 Control Panel

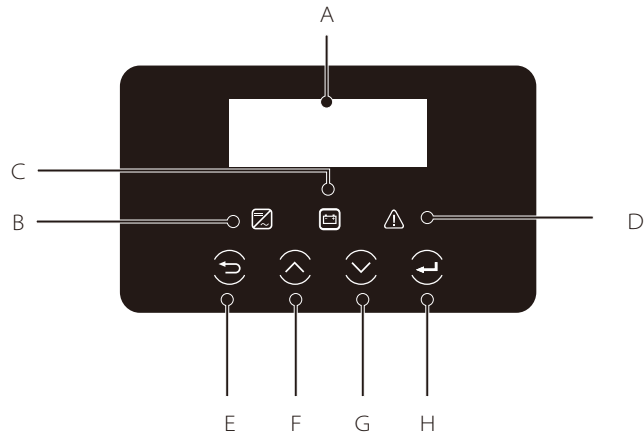

Object	Name	Description
A	LCD Screen	Display the information of the inverter.
B	Indicator LED	lit in blue: The inverter is in normal status or in EPS mode. flash in blue: The inverter is in waiting or checking status. Off: The inverter is in fault status.
C		lit in green: The battery communication is normal and working. flash in green: The battery communication is normal and in idle status. Off: The battery does not communicate with inverter.
D		lit in red: The inverter is in fault status. Off: The inverter has no errors.
E		ESC button: Return from current interface or function.
F	Function Button	Up button: Move cursor to upside or increase value.
G		Down button: Move cursor to downside or decrease value.
H		OK button: Confirm the selection.

## 8.2 Menu Structure

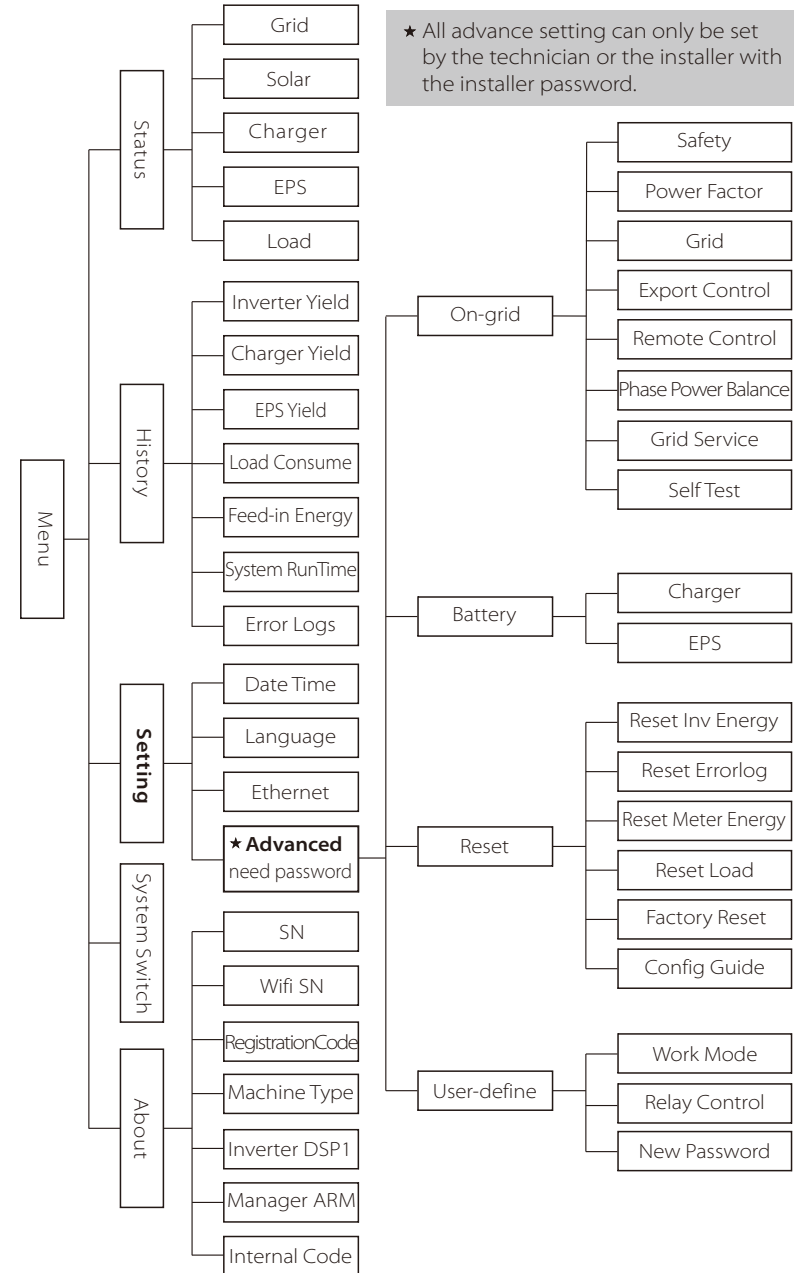

### 8.3 LCD Operation

#### LCD Digital Display

The main interface is the default interface, the inverter will automatically jump to this interface when the system started up successfully or not operated for a period of time.

The information of the interface is as below. "Power" means the instant output power; "Today" means the power generated within the day. "Battery" means the left capacity of battery energy.

Power	0W
Today	0.0KWh
Battery	%
Normal	

#### Menu interface

The menu interface is a transfer interface for user to get into another interface to change the setting or getting the information.

-User can get into this interface by pressing "OK" button when LCD displays the main interface.

-User can select interface by moving the cursor with function button, and press "OK" to confirm.

Menu
Status
History
Settings

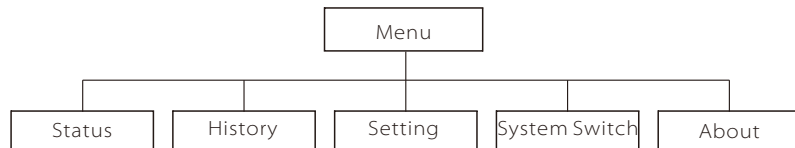

#### ➤ Status

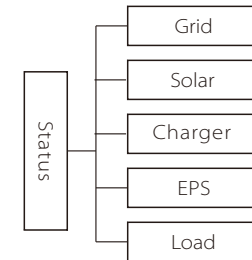

#### ● Status

The status function contains five items of the inverter(grid, solar, charger, eps and Load).

Press up and down to select and press "OK" to confirm the selection, press "ESC" to return to Menu.

Status
Grid
Solar
Charge

#### a) Grid

This status shows the current grid condition such as voltage, current, output power, the local consumed power and frequency.

Pout measures the output of inverter;

Pgrid measures power export to or import from grid.

Positive value means the energy feeds into grid, negative value means the energy used from the grid.

Grid	
Ua	0.0V
Ia	0.0A
PaOut	0W

#### b) Solar

This status shows the real time PV condition of the system, such as input voltage, current and power situation of each PV input.

Solar	
U1	600.0V
I1	7.0A
P1	4200W

C) Charger

This status shows the charger situation of the system. Include the battery voltage, charge or discharge current. Charge or discharge power, battery capacity, battery temperature, BMS status, charge and discharge limit. "+" means in charging; "-" means in discharging.

Charger	
U	400.0V
I	-1.0A
P	-400W

d) EPS

EPS will only have data when the inverter is working in EPS mode, it will show the real time data of the EPS output such as voltage, current, power.

EPS	
PaS	2300VA
Ua	230.0V
Ia	10.0A
Pa	2260W

e) Load

If the inverter is plugged with a smart plug, this status shows the real time load power, include load 1 power and load 2 power.

Load	
> Load 1 Power	0W
> Load 2 Power	0W

➤ History

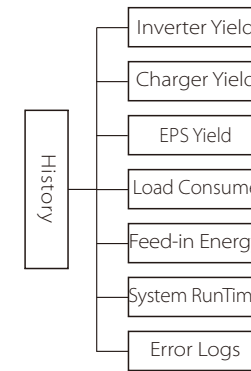

● History

The history function contains seven items of the information: Inverter yield, charger yield, EPS yield, load consume, feed in energy, system run time and error logs. Press up and down to select and press "OK" to confirm the selection, press "ESC" to return to Menu.

History
Inverter Yield
Charger Yield
EPS Yield

a) Inverter Yield

This function contains inverter yield for today, yesterday, this month, last month and total.

Inverter Yield
>Today:
00.0KWH

b) Charger Yield

The charger Yield function contains charger yield for today, yesterday, this month, last month and total.

Charger Yield
>Today:
00.0KWH

c) EPS Yield

The EPS Yield function contains charger yield for today, yesterday, this month, last month and total.

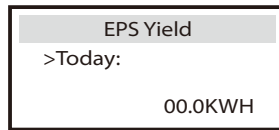

d) Load consume

The Load consume contains the energy consumed by specific loads by today, this month and total.

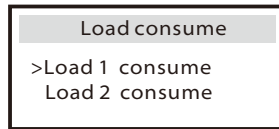

e) Feed in energy

The feed-in energy contains the energy exported to the grid by today, this month and total.

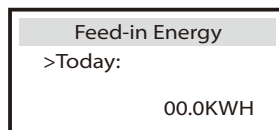

f) System RunTime

This function contains grid mode run time and EPS mode run time.

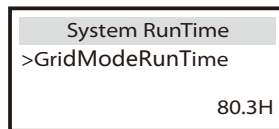

g) Error Logs

The Error logs record the latest six error messages happened.

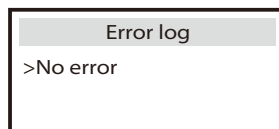

➤ Setting

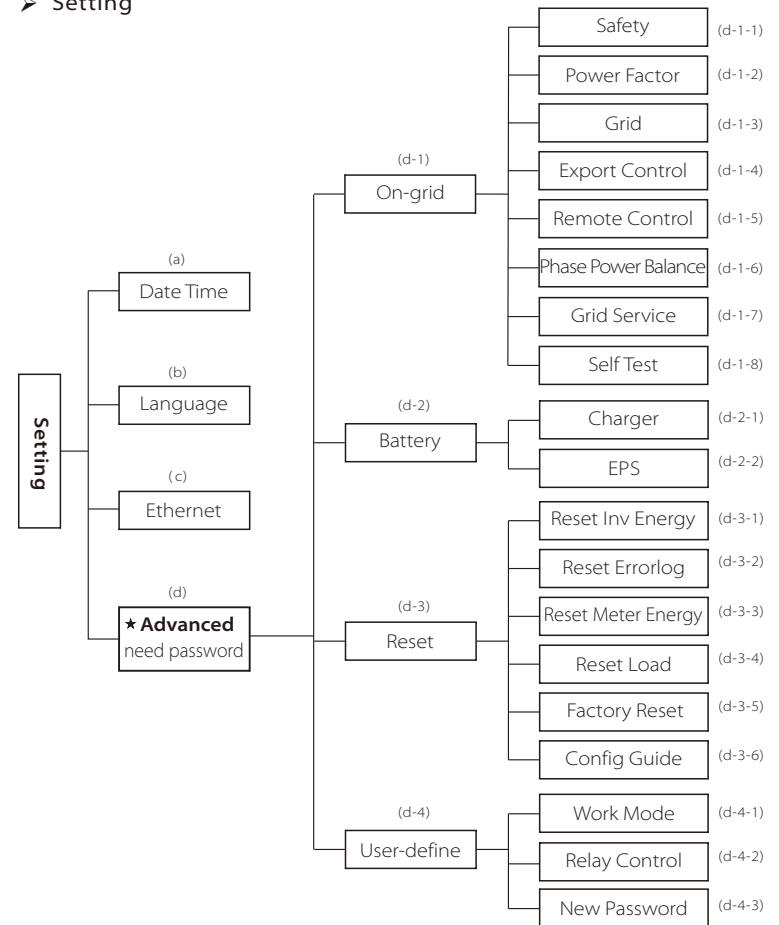

● Setting

This function is used for setting of the inverter time, connection, battery, grid and so on.

Enduser can set Date Time, Language and Ethernet directly.

But for advance setting, it requires installer password to operate most of the professional settings.

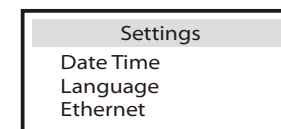

a) Date Time

This interface is for user to set the system date and time.

Date time
2013 ->06 <-06 10:19

b) Language

This inverter provides several languages for customer to select.

Language
English Deutsch

c) Ethernet

There are two modes to obtain IP address: static and DHCP.

User can set the information about ethernet such as IP address, subnet mask number and default gateway number and Mac sdress.

Ethernet
> IP Method static

d) Advanced

All the advance setting can be set here, such as battery, grid, EPS and so on. "Advanced" is divided four parts: On-grid, Battery, Reset, User-define. And every part has lower level parts.

Pls contact with your installer or factory for the installer password to enter.

Advanced
On-grid Battery Reset

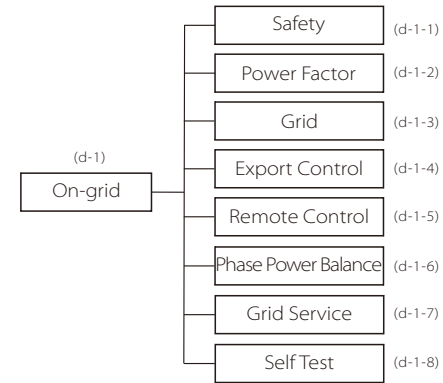

d-1-1) Safety

User can set safety standard according to different countries and grid tied standdards. There are 8 standards to select. (May change without notice)

Item	Standard	Country
1	VDE 0126	German
2	ARN 4105	German
3	AS 4777	Australia
4	G83/2	UK
5	G59/3	UK
6	EN 50438_NL	Netherland
7	CEI 0-21	Italy
8	IEC61727_In	India

d-1-2) Power Factor ( For specific country if required by the local grid.)

There are 5 modes for selecting: Off , Under-Excited, Over-Excited, Curve, Q( u ).

Mode	Comment
Off	-
Over-Excited	PF value
Under-Excited	PF value
Curve	Upper limit
	Lower limit
	Power Upper
	Power Lower
	PFLockInPoint ( CEI 0-21 only) PFLockOutPoint ( CEI 0-21 only)
Q( u )	QuVupRate ( EN50438_NL only)
	QuVlowRate ( EN50438_NL only)
Fixed Q Power	Q Power



**Reactive power control, Reactive standard curve  $\cos \varphi = f(P)$**

For VDE ARN 4105, curve  $\cos \varphi = f(P)$  should refer to curve A. default value of setting is as shown in curve A.

For E 8001, curve  $\cos \varphi = f(P)$  should refer to curve B. default value of setting is as shown in curve B.

For CEI 0-21, default value of PFLockInPoint is 1.05, when  $V_{ac} > 1.05V_n$ , and  $P_{ac} > 0.2 P_n$ , curve  $\cos \varphi = f(P)$  should refer to curve C. Default value of PFLockOutPoint is 0.98, when  $V_{ac} < 0.98 V_n$ ,  $\cos \varphi = f(P)$  will exit curve C.

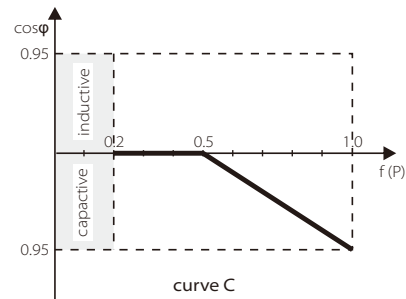
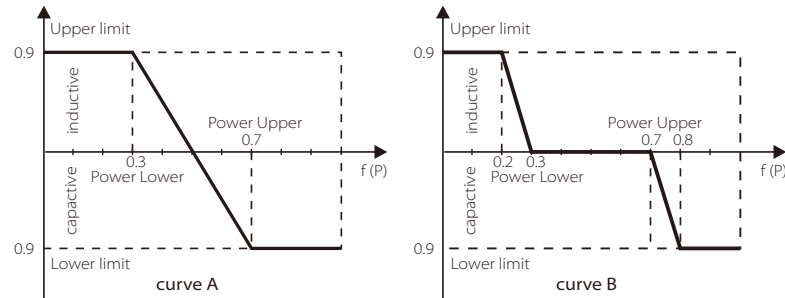

**Reactive power control, Reactive standard curve  $Q = f(V)$**

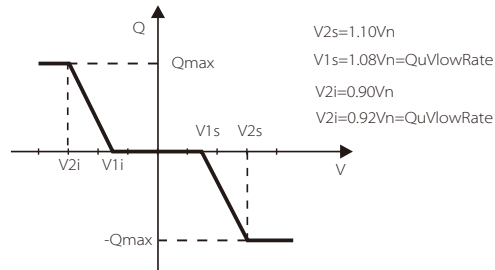

**d-1-3) Grid**

The enduser do not need to set the grid parameters. All default value has set on factory according to safety rules.

If need to reset, any changes should according to the requirement of local grid.

Parameter	Comment
<b>Normally</b>	
Vac upper	Voltage high protect
Vac lower	Voltage low protect
Vac upper slow	Voltage high slow protect
Vac lower slow	Voltage low slow protect
Fac upper	Frequency high protect
Fac lower	Frequency low protect
Fac upper slow	Frequency high slow protect
Fac lower slow	Frequency low slow protect
Vac 10m avg	10 min voltage high protect
<b>Apply to Italy(CEI0-21) only.</b>	
Tuvp_Fast	Overvoltage protect fast time
Tovp_Fast	Undervoltage protect fast time
Tufp_Fast	Overfrequency protect fast time
Tofp_Fast	Underfrequency protect fast time
Tuvp_Slow	Overvoltage protect slow time
Tovp_Slow	Undervoltage protect slow time
Tufp_Slow	Overfrequency protect slow time
Tofp_Slow	Underfrequency protect slow time
FreDrpDlyTime	Frequency droop delay time
<b>Apply to EN50438_NL only.</b>	
FreqSetPoint	Frequency set point
FreqDropRate	Frequency droop rate

d-1-4) Export control

This function allows the inverter able to control energy exported to the grid. There are user value and factory value. The factory value is default which can not be changed by user. The user value setting by installer must be less than the factory value.



d-1-5) Remote control

This function allows external control device to make the inverters remote cluster control through LAN port on the inverter. And it can control the inverter's active power output and reactive power output. The default value is "Enable". If it can connect successfully, it will display "Connecting". Select "Disable" means the function is turn off.

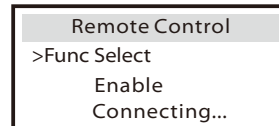

d-1-6) Phase Power Balance

This function controls whether the power output to the grid is balanced. "Enable" means three phases output according to loads, and power feed-in grid is balanced. Select "Disable" means the three phase output power from inverter is balanced and it is the default value.

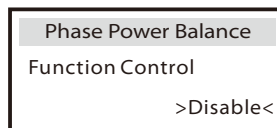

d-1-7) Grid Service

Grid Service can be selected from "Sustain" or "Stop". The default is "Sustain". Every country's requirements for the safety of battery storage inverter is different. some may be opposite to the rights of the user. User can select "Stop" to turn off these features if user receives legal permission.

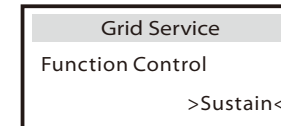

d-1-8) Self Test

User can test operating status of inverter by selecting "All Test". It will enter into the OvpValue test page automatically, a few seconds later, it will display "success" as below, which means the selftest is completed successfully. Press "OK" to enter the next test. After all tests are finished, it will turn back to the "Test Report" page and shows specific parameters.

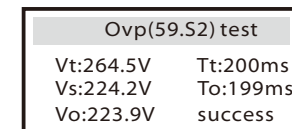
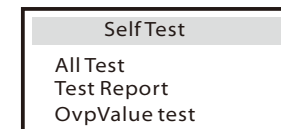

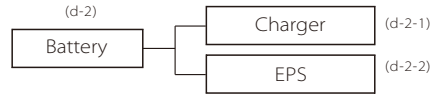

d-2-1) Charger

Here the user can set the parameters of charger on this page, the inverter is only compatible with lithium battery. Users can set the charge & discharge parameters and awaken mode.

For the detailed parameters , please refer to below table.

<b>Charger</b>	<b>Charger</b>	<b>Charger</b>
>Min Capacity 10%	Charge Max Current 25A	Discharge Max Current 25A

Parameter	Comment
Min capacity *	The remaining minimum capacity of the battery.
Charge Max Current	The charge current can be set for 0-25A.
Discharge Max Current	The discharge current can be set for 0-25A.

**NOTE !**  
Please confirm the Inverter setting for maximum charge/discharge current is within the range of battery rated charge/discharge current.

d-2-2) EPS system ( For E Version only)

X3-Hybrid inverter with E Version can work on the EPS mode.

EPS parameters can be set as below.

“Mute”means you can set the warning of system which has entered EPS mode.

–“No”means there will be a buzzing and it is the default value.

–“Yes”means you choose to shut down the warning function.

Besides ,if the buzzing is sharp, it means EPS output is “over loads.”

Frequency “here can be set 50Hz or 60Hz please based on correlative loads.

EPS system	
> Mute:	No
Frequency:	50Hz

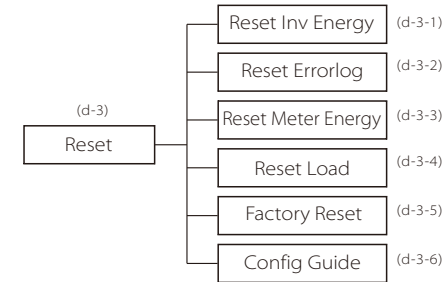

d-3-1) Reset Inv Energy

User can reset the inverter energy record here.

**Reset Inv Energy**

Reset

>No<

d-3-2) Reset Errorlog

User can reset all inverter errorlog record here.

**Reset Errorlog**

Reset

>No<

d-3-3) Reset Meter Energy

User can reset the meter energy record here.

**Reset Met Energy**

Reset

>No<

d-3-4) Reset Load

User can reset the specific load's energy if the inverter is installed with a smart plug.

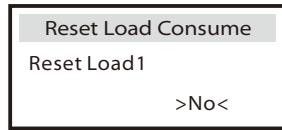

d-3-5) Factory Reset

User can reset the inverter manager parameter records here.

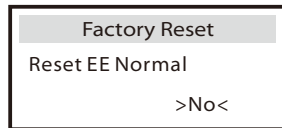

d-3-6) Config guide

This interface will trigger the initial setting guide re-play again.

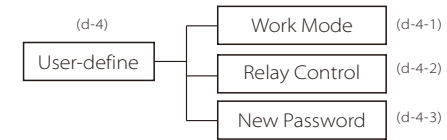
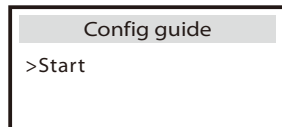

d-4-1) Work mode

There are 4 work modes for choice.

Parameter	Comment
Self Use (default)	The PV generated power will be used to supply the local loads firstly, then to charge the battery. The redundant power will export to the public grid. When there is no PV supplied, battery will discharge for local loads firstly, and grid will supply power when the battery capacity is not enough.
Back Up Mode	The Battery will charging flexibly in the setting time, and it can choose whether charge from the grid or not. The battery stop discharging to keep higher capacity when the grid is on. Only when the grid is off and PV energy is not enough, battery will start to discharge to keep the emergency load working normally. This work mode applies to the area where suffering from blackout regularly.
Feed in Priority	The priority of inverter output power is: supplying the load → feeding to the grid → charging the battery. This work mode applies to the area with high feed-in tariff.
Force Time Use	In this work mode the charging and discharging time can be set flexibly, and it also allows to select whether charge from the grid or not.

- For "Force Time Use" mode, there are 2 parameters that needs to be set.

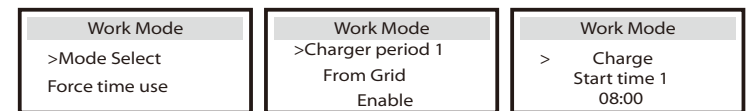

d-4-2) Relay Control

Relay Control is an optional function which can control designated load intelligently by consuming the surplus energy when feed in power reaches certain value.

This function can only be achieved with solax product "Smart Plug".

For specific operation, please refer to "Smart Plug user manual".

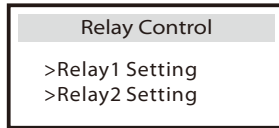

d-4-3) New Password

User can set the new password here.

➤ System Switch

● "System Switch" can be selected from "ON" or "OFF".

"ON" means the inverter is on working condition and it is inverter default status.

"OFF" means the inverter stop delivering all power, but the LCD remains on.

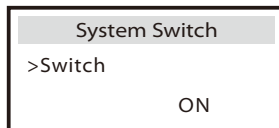

Long press "Enter" key can also switch on "System Switch" "ON" or "OFF".

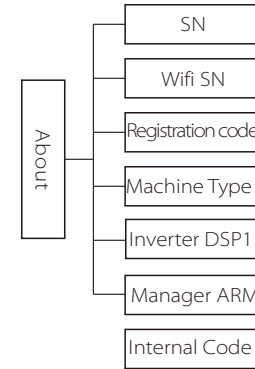
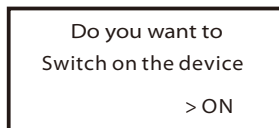

➤ About

● This interface shows information of the inverter including serial number, WiFi serial number, Registration code, machine type, master DSP1, manager ARM and internal code.

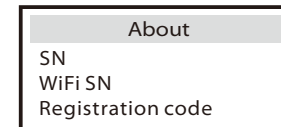

## 9. Troubleshooting

### 9.1 Trouble shooting

This section contains information and procedures for solving possible problems with X3-Hybrid inverters, and provides you with troubleshooting tips to identify and solve most problems that could occur with the X3-Hybrid inverters.

This section will help you narrow down the source of any problems you may encounter. Please read the following troubleshooting steps.

Check warnings or fault messages on System Control Panel or Fault codes on the inverter information panel. If a message is displayed, record it before doing anything further.

Attempt the solution indicated in below table.

Faults	Diagnosis and solution
TZ Protect Fault	Over current Fault. <ul style="list-style-type: none"> <li>• Wait for a while to check if go back to normal status.</li> <li>• Disconnect PV+ , PV- and battery, reconnect them.</li> <li>• Or seek help from us, if can not go back to normal state.</li> </ul>
Grid Lost Fault	Grid is Lost. <ul style="list-style-type: none"> <li>• Please wait for a while and system will reconnect if the utility is back to normal.</li> <li>• Please check whether the cable connection at AC side is normal or not.</li> <li>• Or seek help from us.</li> </ul>
Grid Volt Fault	Grid Voltage Out of Range <ul style="list-style-type: none"> <li>• Please wait for a while and system will reconnect if the utility is back to normal.</li> <li>• Please check whether the grid voltage is in the normal range.</li> <li>• Or seek help from us.</li> </ul>
Grid Freq Fault	Grid Frequency Out of Range <ul style="list-style-type: none"> <li>• System will reconnect if the utility is back to normal.</li> <li>• Or seek help from us.</li> </ul>
PV Volt Fault	PV Voltage Out of Range <ul style="list-style-type: none"> <li>• Check the output voltage of the PV panels.</li> <li>• Or seek for help from us.</li> </ul>
Bus Volt Fault	Bus Voltage Out of Normal Range <ul style="list-style-type: none"> <li>• Disconnect PV+ , PV- and battery, reconnect them.</li> <li>• Check if the PV input is within the range of the inverter.</li> <li>• Or seek help from us, if can not go back to normal state.</li> </ul>
Bat Volt Fault	Battery Voltage Fault <ul style="list-style-type: none"> <li>• Check if the battery input voltage is within the normal range</li> <li>• Or seek help from us.</li> </ul>

Faults	Diagnosis and solution
AC10M Volt Fault	The grid voltage is out of range for the last 10 Minutes. <ul style="list-style-type: none"> <li>• The system will back to normal if the grid is back.</li> <li>• Or seek for help from us.</li> </ul>
DCI OCP Fault	DCI over current protection Fault. <ul style="list-style-type: none"> <li>• Wait for a while to check if back to normal.</li> <li>• Or seek for help from us.</li> </ul>
DCV OCP Fault	DCV EPS over voltage protection Fault. <ul style="list-style-type: none"> <li>• Wait for a while to check if back to normal.</li> <li>• Or seek for help from us.</li> </ul>
SW OCP Fault	Over current fault detected by software. <ul style="list-style-type: none"> <li>• Wait for a while to check if back to normal.</li> <li>• Turn off the PV, battery and grid , reconnect them.</li> <li>• Or seek for help from us.</li> </ul>
RC OCP Fault	DCI over current protection Fault. <ul style="list-style-type: none"> <li>• Please check if the insulation of electric wires are damaged.</li> <li>• Wait for a while to check if back to normal.</li> <li>• Or seek for help from us.</li> </ul>
Isolation Fault	Isolation Fault <ul style="list-style-type: none"> <li>• Please check if the insulation of electric wires are damaged.</li> <li>• Wait for a while to check if back to normal.</li> <li>• Or seek for help from us.</li> </ul>
Temp Over Fault	Temperature over the limitation <ul style="list-style-type: none"> <li>• Check if the environment temperature is over limitation.</li> <li>• Or seek help from us.</li> </ul>
BatConDir Fault	Battery Reverse Connection Fault <ul style="list-style-type: none"> <li>• Check if the positive pole and negative pole of battery are connected in a contrary way</li> <li>• Or seek help from us.</li> </ul>
Sample Fault	The detection circuit Fault <ul style="list-style-type: none"> <li>• Disconnect PV+ , PV- and battery, reconnect them.</li> <li>• Or seek help from us.</li> </ul>
OverLoad Fault	Over Load in EPS Mode. <ul style="list-style-type: none"> <li>• Turn off high power device , press "ESC" to restart the inverter.</li> <li>• Or seek help from us, if can not go back to normal state.</li> </ul>
EPS OCP Fault	Over Current in EPS Mode. <ul style="list-style-type: none"> <li>• Make sure the load power is within the EPS power range.</li> <li>• Check if any nonlinear load is connect on the EPS. Remove this load to check if can recover.</li> <li>• Or seek help from us, if can not go back to normal state.</li> </ul>
Input Cnf Fault	PV Panel connection abnormal <ul style="list-style-type: none"> <li>• Check if two MPPTs connect in a parallel mode. Please connect the two MPPTs independently.</li> <li>• Or seek help from us, if can not go back to normal state.</li> </ul>

Faults	Diagnosis and solution
FWunmatched	Firmware Version Fault • Check if the ARM version is matched. • Or seek help from us, if can not go back to normal state.
BatPowerLow	EPS Battery Power Low • Charge the battery. • Turn off high power device , press "ESC" to restart the inverter. • Or seek help from us, if can not go back to normal state.
PhaseAngleFault	Phase Angle Fault • Please check whether the AC connection is correct. • The system will back to normal if the grid is normal. • Or seek help from us, if can not go back to normal state.
PLL_OverTime Fault	PLL_OverTime Fault • Please check whether the AC connection is correct. • The system will back to normal if the grid is normal. • Or seek help from us, if can not go back to normal state.
Parallel Fault	Parallel Fault • Parallel system has two or more master machine. • The DSP1 version is different. • Or seek help from us, if can not go back to normal state.
Inter Com Fault	Internal Communication Fault • Turn off the PV, battery and grid , reconnect them. • Or seek help from us, if can not go back to normal state.
DSP System Fault	System Fault • Seek help from us, if can not go back to normal state.
AC HCT Fault	AC Current Sensor Fault • Turn off the PV, battery and grid , reconnect them. • Or seek help from us, if can not go back to normal state.
Inv EEPROM Fault	Inverter EEPROM Fault • Turn off the PV, battery and grid , reconnect them. • Or seek help from us, if can not go back to normal state.
RCD Fault	Residual Current Device Fault • Check the impedance of DC input and AC output. • Disconnect PV+ , PV- and battery, reconnect them. • Or seek help from us, if can not go back to normal state.
EPS Relay Fault	EPS Relay Fault • Disconnect PV+ , PV- , grid and battery, reconnect them. • Or seek help from us, if can not go back to normal state.
Grid Relay Fault	EPS Relay Fault • Disconnect PV+ , PV- , grid and battery, reconnect them. • Or seek help from us, if can not go back to normal state.
BatRelayFault	Other Devide Fault • Disconnect PV+ , PV- , grid and battery, reconnect them. • Or seek help from us, if can not go back to normal state.

Faults	Diagnosis and solution
BMS_External_Err	Battery Fault-external fault • Please contact battery supplier.
BMS_Internal_Err	Battery Fault-intarnal fault • Please contact battery supplier.
BMS_OverVoltage	Battery Fault-overvoltage fault • Please contact battery supplier.
BMS_LowerVoltage	Battery Fault-undervoltage fault • Please contact battery supplier.
BMS_ChargeOCP	Battery Fault-charge overcurrent fault • Please contact battery supplier.
BMS_DischargeOCP	Battery Fault-discharge overcurrent fault • Please contact battery supplier.
BMS_TemHigh	Battery Fault-over-temperature fault • Please contact battery supplier.
BMS_TemLow	Battery Fault-under-temperature fault • Please contact battery supplier.
BMS_Cellmblance	Battery Fault-cell imbalance fault • Please contact battery supplier.
Mgr EEPROM Fault	Manager EEPROM Fault. • Turn off the PV, battery and grid , reconnect them. • Or seek for help from us if can not back to normal.
DSPunmatched	DSP Version Fault. • Please check if the DSP1 version is matched. • Or seek for help from us if can not back to normal.
Meter Fault	Meter Fault. • Please check if the meter is in normal working. • Or seek for help from us if can not back to normal.

- If your inverter's information panel is not displaying a Fault light, check the following list to make sure that the present state of the installation allows proper operation of the unit.
  - Is the inverter located in a clean, dry, adequately ventilated place?
  - Have the DC input breakers been opened?
  - Are the cables adequately sized and short enough?
  - Are the input and output connections and wiring in good condition?
  - Are the configurations settings correct for your particular installation?
  - Are the display panel and the communications cable properly connected and undamaged?

Contact SolaX Customer Service for further assistance. Please be prepared to describe details of your system installation and provide model and serial number of the unit.

## 9.2 Routine Maintenance

Inverters do not need any maintenance or correction in most condition, but if the inverter often loses power due to overheating, this can be the following reason:

- The cooling fins on the rear of house are covered by dirt.
- Clean the cooling fins with a soft dry cloth or brush if necessary.

**Only trained and authorized professional personnel who are familiar with the requirements of safety was allowed to perform servicing and maintenance work.**

### ➤ Safety checks

Safety checks should be performed at least every 12 months, please contact manufacturer to arrange qualified person who has adequate training, knowledge, and practical experience to perform these tests. (Please kindly noted this action is not covered by warranty). The data should be recorded in an equipment log. If the device is not functioning properly or fails any of test, the device has to be repaired. For safety check details, refer to this manual, section 2 Safety instruction and EC Directives.

### ➤ Maintain Periodically

Only qualified person may perform the following works.

During the process of using the inverter, the manager person shall examine and maintain the machine regularly. The concrete operations are follow.

- 1: Check that if the cooling fins on the rear of house are covered by dirt, and the machine should be cleaned and absorbed dust when necessary. This work shall be check time to time.
- 2: Check that if the indicators of the inverter are in normal state, check if the keys of the inverter are in normal state, check if the display of the inverter is normal. This check should be performed at least every 6 months.
- 3: Check that if the input and output wires are damaged or aged. This check should be performed at least every 6 months.
- 4: You should keep the inverter panels clean and their security checked at least every 6 months.

## 10. Decommissioning

### 10.1 Remove the Inverter

- Disconnect the inverter from DC Input and AC output.
- Wait for 5 minutes for de-energizing.
- Disconnect communication and optional connection wirings.
- Remove the inverter from the bracket.
- Remove the bracket if necessary.

### 10.2 Packaging

Please pack the inverter with the original packaging.

If the original package is no longer available, you can also use an equivalent carton that meets the following requirements.

- Suitable for loads more than 30 kg.
- With handle.
- Can be fully closed.

### 10.3 Storage and Transportation

Store the inverter in a dry environment where ambient temperature keep always between -20 °C - +60 °C. Take care of the inverter during the storage and transportation, keep less than 4 cartons in one stack.

When the inverter or other related components need to be disposed. Have it carried out according to local waste handling regulations. Please be sure to deliver wasted inverters and packing materials to certain site, where can assist relevant department to dispose and recycle.



